



PAVEMENT CONDITION SURVEYS

5.1 Module Objectives

The objectives of this module are to enable participants to:

- Understand the need for condition surveys.
- Be familiar with the four basic types of condition surveys.
- Acquaint participants with the different procedures and equipment available.
- Be aware of the purpose, advantage and disadvantage of different procedures.

5.2 Introduction

In the previous module, the inventory defined the network for which the pavement engineer is responsible. In this module, Condition Surveys are used to assess or describe the state of being, or readiness for use, of those elements being managed. It has also been described as a means of determining the “health” of the network.

A condition survey is the process of collecting data to determine the structural integrity, distresses, skid resistance, and overall riding quality of the pavement. Traditionally, maintenance or engineering personnel relied on experience and visual inspections to schedule maintenance. The problems with that technique are that experience is difficult to transfer from one person to another and decisions made using similar data often vary considerably. Condition surveys provide a rational and consistent method of allocating limited resources.

By monitoring the pavement condition using the methods described here, an agency should be able to:

- Evaluate the current condition of the network.
- Determine the rates of deterioration.
- Project future conditions.
- Determine maintenance and rehabilitation needs.
- Determine the costs of repair.
- Prepare plans for repairs.
- Determine the effects of budget reductions and deferred maintenance.
- Schedule future pavement maintenance activities.
- Track performance of various pavement designs and materials.

There are several methods available for defining the current condition of a pavement segment. Many of the pavement management systems (PMS) available use a specific method of collecting condition data and defining states of pavement readiness or condition. Adopting a specific PMS will often require the adoption of specific data collection procedures.

Since so many decisions supported by the PMS are based on the condition assessment, it is important to ensure that the data collected and used is accurate enough to provide the desired level of support. However, since the collection of condition data is the

most expensive portion of maintaining the PMS, the cost must be matched to the resources and needs of the adopting agency.

The published literature on condition surveys is extensive and exhaustive. Much of the previously published work, as well as past NHI courses, are summarized herein. Previous PMS courses were especially useful in compiling this module. The focus of this module will be on “new” types of procedures and equipment.

5.3 Collection Methodologies

Collecting condition information is generally the most costly part of the initial implementation of a PMS and of continued operation. Condition data can be collected using very expensive or relatively inexpensive methods. In general, the detail and accuracy of data collection varies from very detailed for research activities to very gross for some network-level management systems. It is not necessary to have the same detail at each level; however, it is important to use the same general definitions at each level. It is not necessary to collect all of the data at each level. Some measures, such as structural evaluation, may only be collected at the project-level. Other measures, such as surface friction, may only be used when a specific problem has been identified.

Many different methods are available to collect each of these condition measures. The methods that are more costly are also usually more accurate, more precise, and have the greatest resolution. Accuracy is the degree to which the method provides a true value. Precision is the repeatability among multiple measurements. Resolution is the smallest increment that can be measured. The precision, accuracy, and resolution needed depend on the goals of the pavement management system and the funds available to pay for the inspection services. Some methods are more subjective than others. References 1 and 3 describe many of the data collection methods and equipment in some detail. Reference 4 discusses many of the automated or semi-automated procedures for collecting and analyzing distress data. Reference 5 presents some criteria that should be considered in selecting the data and collection methods.

5.4 Types of Surveys

Assessing the pavement condition begins with collecting data. This data is then interpreted to define the current state of readiness, or “health” of the pavement. There are generally four types of surveys (1):

- Distress Surveys
- Structural Capacity
- Roughness (ride quality)
- Skid Resistance (surface friction)

The basic purpose of a pavement is to provide a safe and smooth surface for the travelling public. The travelling public is primarily interested in this functional condition, which is primarily measured with roughness and surface friction. The engineers and managers are interested in developing the most cost-effective maintenance and rehabilitation program. They are interested in an engineering analysis of the condition, as well as the functional condition. Distress surveys and structural testing are normally used in the engineering analysis.

PAVEMENT CONDITION SURVEYS

DISTRESS SURVEYS: Surface distress is damage observed on the pavement surface. Distress surveys are performed to determine the type, severity, and quantity of surface distress. This information is often used to determine a pavement condition index (PCI), which helps compute a rate of deterioration, and is often used to project future condition (2). Surface distress and the current or future PCI values are often used to help identify the timing of maintenance and rehabilitation as well as funding needs in the PMS process. Distress is the measure most used by maintenance personnel to determine what type of maintenance treatment is required and when maintenance is needed. It is typically the most important type of condition survey.

STRUCTURAL CAPACITY: Structural capacity is the maximum load and number of repetitions a pavement can carry before reaching some defined condition. Structural analysis is normally conducted at the project-level to determine the pavement load-carrying capacity and the capacity needed to accommodate projected traffic. Non-destructive deflection testing of the pavement is a simple and reliable method to assist in making this evaluation; however, destructive testing such as coring and component analysis techniques may be used as well. Pavement structural evaluation is important in the selection of treatments at the project-level

ROUGHNESS (RIDE QUALITY): Roughness, or ride quality, is a measure of pavement surface distortion along a linear plane or an estimate of the ability of the pavement to provide a comfortable ride to the users. Roughness is often converted into an index such as the Present Serviceability Index (PSI) or the International Roughness Index (IRI). Pavement roughness is considered most important by the using public, and it is especially important on pavements with higher speed limits, those above 45 miles (70 km) per hour. It is considered very important by state highway agencies, but is generally of less importance to cities because of the difference in speed limits as well as the causes of roughness.

SKID RESISTANCE (SURFACE FRICTION): Skid resistance, or surface friction, indicates the ability of the pavement surface to provide sufficient friction to avoid skid related safety problems. Skid resistance is most important on pavements with high speeds. It is generally considered a separate measure of the condition of the pavement surface and often can be used to determine the need for remedial maintenance by itself. Many agencies use accident maps to identify high accident areas, and then an assessment is made as to whether the accidents are related to friction problems. Measurements of surface friction can be used to help eliminate potential problem spots before accidents occur.

Skid resistance measurements are expressed as a skid number. On highway pavements, skid measurements are usually made with locked wheel skid trailers. Measurement of skid resistance is not typically associated with a PMS at the local level.

SUMMARY OF SURVEY TYPES: These four pavement condition factors can be used to determine the overall pavement condition and to identify the most cost-effective and optimum maintenance and rehabilitation treatment. The pavement condition factors discussed above vary in their degree of importance in terms of pavement performance and maintenance and rehabilitation needs. It is obvious that a treatment recommended to correct the structural load-carrying capacity of the pavement can be designed to correct

all other deficiencies that might be present, including roughness. Also, a treatment selected to correct pavement roughness can be used in turn to improve the surface friction and correct any surface distress as well.

Various methods are available to collect each of the four measures. Each method has advantages and disadvantages. Again, to emphasize, those procedures which require the least time and cost are also the least accurate. Those which are most accurate are also the most expensive and time consuming. An agency must carefully consider the type and level of decisions being made along with the resources available to determine the best method and correct measures for their system. There is considerable variation in the cost and accuracy of data collected. In general, most agencies use less accurate methods for network-level analysis and more detailed measures for project-level analysis. However, the network and project-level methods should complement each other.

SURVEY FREQUENCIES: The frequency of surveys depends upon several factors. These include pavement type, age, current condition, average daily traffic, axle loadings, drainage characteristics, and weather factors. Of these factors, current conditions, axle loadings and drainage are the most important.

Traffic loadings are usually consistent within each road class. Therefore, if traffic and axle loading data are not readily available, it may be reasonable to assign survey frequency by functional classification. For instance, arterials might be inspected annually, collectors every two years, and residential streets every four years.

Frequency also depends on the pavement condition of individual sections. New pavements or pavements in good condition require less frequent inspections than pavements that are experiencing high rates of deterioration.

5.5 Distress Surveys

Distress surveys can be performed manually, or automated equipment may be used. In either case, the surface of the pavement is viewed and evaluation is made to determine the following:

- Type of distress.
- Severity.
- Quantity of distress present on the pavement surface.

The type of distress tells us what type of damage has developed; the severity tells how bad the damage is; and the quantity gives us the extent of the type and severity of damage that is present. All three of these factors are required to get a full picture of the damage that has developed on the pavement surface and are used to determine the type and timing of maintenance, rehabilitation, and reconstruction.

There have been several iterations in the development of standard definitions of types of distress and levels of severity. The definitions used in the PAVER system are some of the most commonly used by local agencies (6,7); however, they are often criticized because there are too many distress types required by PAVER (19 each for asphalt and concrete surfaced pavements, 7 for unsurfaced roads). Since PAVER was developed for worldwide use, a full set of distress types were needed. However, in a single area,

PAVEMENT CONDITION SURVEYS

fewer distress types will normally be present and even less may influence management decisions. Some agencies have modified the PAVER distress types and severity levels to make them more easy to use and to match the conditions found in a local area (8). One such example is the Metropolitan Transportation Commission's PMS in California.

Distress severity levels have also evolved. Some state agencies and the Federal Highway Administration using the Strategic Highway Research Program (SHRP) Distress Identification Manual for Long-Term Pavement Performance (9) have tried to avoid using severity levels and rely on direct measures to define the severity and reduce subjectivity. (See Table 5.1). This is appropriate for such distress types as rutting where direct depth measurements can be made. However, most agencies are still using distress severities, and even the SHRP manual uses severity levels for some distress types. The number of severity levels has varied among distress identification systems from two to seven. Most agencies currently use three. Generally, the low severity level identifies that the distress type has appeared but that it is not causing a problem at this point. A high or heavy severity level generally indicates that the distress is so bad that maintenance is needed immediately or should have already been performed.

The medium or moderate severity level generally indicates that the distress has progressed to the point where the pavement needs attention or it will become a problem shortly. This provides adequate information to define the level of damage that is present and to help identify when treatments should be applied. It also gives adequate information needed to calculate a condition index that can be used to project future condition.

In summary, a good pavement distress survey will collect data necessary to:

- Identify roads which need no immediate maintenance and therefore, no immediate expenditures.
- Identify roads which require a minor or routine maintenance and immediate expenditures.
- Identify roads which require preventive maintenance activities such as asphalt overlay, seal, etc. These roads can be listed in order of priority and the maintenance activities can be scheduled accordingly.
- Identify roads which need major rehabilitation or reconstruction. These roads will have deteriorated to the point that maintenance is no longer cost-effective and more major work is required to raise the condition to an acceptable level.

Appendix 5A is an example of the state of New Mexico's distress definitions and procedures.

PAVEMENT CONDITION SURVEYS

Table 5.1 Distress Types from SHRP (9)

ASPHALT CONCRETE SURFACES	
1. Fatigue Cracking	9. Rutting
2. Block Cracking	10. Shoving
3. Edge Cracking	11. Bleeding
4. Longitudinal Cracking	12. Polished Aggregate
5. Reflection-Cracking At Joints	13. Raveling
6. Transverse Cracking	14. Lane-to-shoulder drop-off
7. Patch/Patch Deterioration	15. Water Bleeding & Pumping
8. Potholes	
JOINTED PORTLAND CEMENT CONCRETE SURFACES	
1. Corner Breaks	9. Polished Aggregate
2. Durability Cracking	10. Popouts
3. Longitudinal Cracking	11. Blow-ups
4. Transverse Cracking Joints/Cracks	12. Faulting of Transverse
5. Joint Seal Damage	13. Lane-to-shoulder drop-off
6. Spalling of Longitudinal Joints	14. Lane-to-shoulder separation
7. Spalling of Transverse Joints	15. Patch/Patch Deterioration
8. Map Cracking & Scaling	16. Water Bleeding & Pumping
CONTINUOUSLY REINFORCED CONCRETE SURFACES	
1. Durability Cracking	9. Lane-to-shoulder drop-off
2. Longitudinal Cracking	10. Lane-to-shoulder separation
3. Transverse Cracking	11. Patch/Patch Deterioration
4. Map Cracking & Scaling	12. Punchouts
5. Polished Aggregate	13. Spalling of Longitudinal Joints
6. Popouts	14. Water Bleeding & Pumping
7. Blowups	15. Longitudinal Joint Seal Damage
8. Transverse Construction Joint Deterioration	

PAVEMENT CONDITION SURVEYS

Tables 5.2 and 5.3 are the SHRP descriptions for distress types found in asphalt and Portland cement concrete pavements.

TABLE 5.2 Distress Definitions for Asphalt Surfaced Pavements (9)

DISTRESS TYPE	DESCRIPTION
Bleeding	Excess bituminous binder occurring on the pavement surface. May create a shiny, glass-like, reflective surface that may be tacky to the touch. Usually found in the wheel paths.
Block Cracking	A pattern of cracks that divides the pavement into approximately rectangular pieces. Rectangular blocks range in size from approximately 0.1 sq. m to 10 sq. m (1 sq. ft to 100 sq ft).
Edge Cracking	Applies only to pavements with <u>unpaved shoulders</u> . Crescent shaped cracks or fairly continuous cracks which intersect the pavement edge and are located within 0.6 m (2 ft) of the pavement edge, adjacent to the shoulder. Includes longitudinal cracks outside of the wheel path and within 0.6 m (2 ft) of the pavement edge.
Fatigue Cracking	Occurs in areas subjected to repeated traffic loadings (wheel paths). Can be a series of interconnected cracks in early stages of development. Develops into many-sided, sharp-angled pieces, usually less than 0.3 m (1 ft) on the longest side characteristically with a chicken wire/alligator pattern, in later stages. Must have a <u>quantifiable area</u> .
Lane-to-shoulder drop-off	Difference in elevation between the traveled surface and the outside shoulder. Typically occurs when the outside shoulder settles as a result of pavement layer material differences.
Longitudinal Cracking	Cracks predominantly parallel to pavement centerline. Location within the lane (wheel path versus non-wheel path) is significant.
Patch/Patch Deterioration	Portion of pavement surface, greater than 0.1 sq. m (1 sq. ft), that has been removed and replaced or additional material applied to the pavement after original construction.
Polished Aggregate	Surface binder worn away to expose coarse aggregate.
Potholes	Bowl-shaped holes of various sizes in the pavement surface. Minimum plan dimension is 15 cm (6 in).
Raveling	Wearing away of the pavement surface in high-quality hot mix asphalt concrete. Caused by the dislodging of aggregate particles and loss of asphalt binder.
Reflection Cracking At Joints	Cracks in asphalt concrete overlay surfaces that occur over joints in concrete pavements. Note: Knowing the slab dimensions beneath the asphalt concrete surface helps to identify reflection cracks at joints.
Rutting	A rut is a longitudinal surface depression in the wheel path. It may have associated transverse displacement.
Shoving	Shoving is a <u>longitudinal displacement</u> of a localized area of the pavement surface. It is generally caused by braking or accelerating vehicles, and is usually located on hills or curves, or at intersections. It also may have associated vertical displacement.
Transverse Cracking	Cracks that are predominantly perpendicular to pavement centerline, and are not located over Portland cement concrete joints.
Water Bleeding and Pumping	Seeping or ejection of water from beneath the pavement through cracks. In some cases, detectable by deposits of fine material left on the pavement surface which were eroded (pumped) from the support layers and have stained the surface.

PAVEMENT CONDITION SURVEYS

TABLE 5.3 Distress Description For Portland Cement Concrete Surfaces (9)

DISTRESS TYPE	DESCRIPTION
Blowups	Localized upward movement of the pavement surface at transverse joints or cracks, often accompanied by shattering of the concrete in that area.
Corner Breaks	A portion of the slab separated by a crack, which intersects the adjacent transverse and longitudinal joints, describing approximately a 45 degree angle with the direction of traffic. The length of the sides is from 0.3 m (1 ft) to one-half the width of the slab, on each side of the corner. Closely spaced crescent-shaped hairline cracking pattern. Occurs adjacent to joints, cracks, or free edges; initiating in slab corners.
Durability Cracking ("D" Cracking)	Closely spaced crescent-shaped hairline cracking pattern. Occurs adjacent to joints, cracks, or free edges; initiating in slab corners.. Dark coloring of the cracking pattern and surrounding area.
Faulting of Transverse Joints and Cracks	Difference in elevation across a joint or crack.
Joint Seal Damage	Joint seal damage is any condition which enables incompressible materials or a significant amount of water to infiltrate the joint from the surface. Typical types of joint seal damage are: Extrusion, hardening, adhesive failure (bonding), cohesive failure (splitting), or complete loss of sealant. Intrusion of foreign material in the joint. Weed growth in the joint.
Lane-to-shoulder drop-off	Difference in elevation between the edge of slab and outside shoulder; typically occurs when the outside shoulder settles.
Lane-to-shoulder separation	Widening of the joint between the edge of the slab and the shoulder.
Longitudinal Cracking	Cracks that are predominantly parallel to the pavement centerline.
Map Cracking	A series of cracks that extend only into the upper surface of the slab. Frequently, larger cracks are oriented in the longitudinal direction of the pavement and are interconnected by finer transverse or random cracks.
Scaling	Scaling is the deterioration of the upper concrete slab surface, normally 3 mm (0.125 in.) to (0.5 in.), and may occur anywhere over the pavement.
Patch/Patch Deterioration	A portion, greater than 0.1 sq. m (1 sq. ft), or all of the original concrete slab that has been removed or replaced, or additional material applied to the pavement after original construction.
Polished Aggregate	Surface mortar and texturing worn away to expose coarse aggregate.
Popouts	Small pieces of pavement broken loose from the surface, normally ranging in diameter from 25 mm (1 in.) to 100 mm (4 in.) and depth from 13 mm (0.5 in.) to 50 mm (2 in.).
Spalling of Longitudinal Joints	Cracking, breaking, chipping or fraying of slab edges within 0.6 m (2ft) of the longitudinal joint.
Spalling of Transverse Joints	Cracking, breaking, chipping or fraying of Lac edges within 0.6 m (2ft) of the transverse joint.
Transverse Cracking	Cracks that are predominantly perpendicular to the pavement centerline..
Water Bleeding and Pumping	Seeping or ejection of water from beneath the pavement through cracks. In some cases detectable by deposits of fine material left on the pavement surface, which were eroded (pumped) from the support layers and have sustained the surface.
Transverse Construction Joint Deterioration	Series of closely spaced transverse cracks or a larger number of interconnecting cracks occurring near the construction joint.
Punchouts (CRCP only)	The area enclosed by two closely spaced (usually less than 0.6 m [2ft]) transverse cracks, a short longitudinal crack, and the edge of the pavement or a longitudinal joint. Also includes "Y" cracks that exhibit spalling, breakup, and faulting.

PAVEMENT CONDITION SURVEYS

Tables 5.4 and 5.5 are descriptions of distress types found in aggregate-surfaced and brick, block or cobblestone pavements, respectively.

Table 5.4 Distress Types for Aggregate Surfaced Pavements (10)

DISTRESS TYPE	DESCRIPTION
Corrugations	Corrugations (also known as washboarding) are closely spaced ridges and valleys (ripples) at fairly regular intervals. The ridges are perpendicular to the traffic direction. This type of distress is usually caused by traffic and loose aggregate. These ridges usually form on hills, on curves, in areas of acceleration or deceleration, or in areas where the road is soft or potholed.
Dust Generation	The wear and tear of traffic on unsurfaced roads will eventually loosen the larger particles from the soil binder. As traffic passes, dust clouds create a danger to trailing or passing vehicles and cause significant environmental problems.
Improper Cross Section	An unsurfaced road should have a crown with enough slope from the centerline to the shoulder to drain all water from the road's surface. No crown is used on curves, because they are usually banked. The cross section is improper when the road surface is not shaped or maintained to carry water to the ditches.
Inadequate Roadside Drainage	Poor drainage causes water to pond. Drainage becomes a problem when ditches and culverts are not in good enough condition to direct and carry runoff water because of improper shape or maintenance.
Loose Aggregate	The wear and tear of traffic on unsurfaced roads will eventually loosen the larger aggregate particles from the soil binder. This leads to loose aggregate particles on the road surface or shoulder. Traffic moves loose aggregate particles away from the normal road wheel path and forms berms in the center or along the shoulder (the less-traveled areas).
Potholes	Potholes are bowl-shaped depressions in the road surface. They are usually less than 3 feet in diameter. Potholes are produced when traffic wears away small pieces of the road surface. They grow faster when water collects inside the hole. The road then continues to disintegrate because of loosening surface material or weak spots in the underlying soils.
Ruts	A rut is a surface depression in the wheel path that is parallel to the road centerline. Ruts are caused by a permanent deformation in any of the road layers or subgrade. They result from repeated vehicle passes, especially when the road is soft. Significant rutting can destroy a road.

PAVEMENT CONDITION SURVEYS

Table 5.5 Distress Types for Brick, Block or Cobblestone Pavements (10)

Distress Type	Description
Displacement	Localized surface areas with horizontally displaced brick or block caused by slipping or shoving of the base material.
Heaving	Bumps caused by frost heave, swelling soils, or displacement of base material.
Pothole	Depressions in the pavement surface resulting from loss of brick or block.
Rutting	Surface depressions in the wheel path.
Settlement	Difference in elevation across joints between paving blocks or bricks; usually due to consolidation or loss of the subgrade soil.

AASHTO DISTRESS SURVEY PROTOCOLS: Continuous work is being performed to standardize the definitions and procedures for collection of pavement surface distresses nationwide. NHI is currently offering a course on the SHRP Distress Identification Manual (9) where the emphasis is on standardizing distress definitions. The SHRP manual considers distress type of asphalt concrete, jointed Portland cement concrete and continuously reinforced Portland cement concrete pavements. A 1994 survey (27) found the widest variation among states in the collection and use of pavement distress information. There is little evidence of standardization, and the report encourages the incorporation of SHRP methods to facilitate the exchange of pavement condition information.

In addition, the FHWA is in the process of developing data collection protocols for pavement distresses. A final draft was completed in October 1996 and distributed to the states for comments. The protocols were developed with the input for 5 states (Georgia, Pennsylvania, Massachusetts, Kentucky, and South Dakota) as well as AASHTO and the American Society for Testing Methods (ASTM).

The protocols include the following:

- § Cracking protocols for asphalt pavements
- § Cracking protocols on jointed concrete pavements
- § Cracking protocols for continuously reinforced concrete pavements
- § Faulting protocols for concrete pavements
- § Rut depth protocols for asphalt pavements
- § Roughness protocols

PAVEMENT CONDITION SURVEYS

Each protocol contains a definition of the distress type, the three severity levels and the procedure for rating using both manual and automated surveys. In addition, a section on quality assurance is included.

It is anticipated that the final protocols will be published in 1997 and be included in the American Association of State Highway & Transportation Officials' (AASHTO) new guide for pavement management (expected to be completed in 1998 or 1999).

Appendix 5B contains the final draft (dated October 1996) of the so-called AASHTO protocols.

MANUAL DISTRESS SURVEYS: Manual distress collection can vary from a detailed walking survey to a riding survey at 50 miles (80 km) per hour. In general, the methods in use include the following:

1. A detailed walking survey of 100% of the pavement surface in which all distress types, severities, and quantities are measured, recorded, and *mapped*;
2. A detailed walking survey of 100% of the pavement surface in which all distress types, severities, and quantities are measured and recorded;
3. A walking survey of a *sample* of the pavement surface in which all distress types, severities, and quantities within the sample areas are measured and recorded;
4. A walking survey of a *sample* of the pavement surface in which all distress types, severities, and quantities within the sample areas are *estimated* and recorded;
5. A windshield survey in which distress types, severities and quantities are estimated while riding on the shoulder at a slow speed with periodic stops where selected distress types, severities, and quantities within the selected area are estimated and recorded while walking;
6. A windshield survey at normal traffic speeds in which some distress types, severities, and quantities are estimated while riding with periodic stops where distress types, severities, and quantities within the selected area are estimated and recorded while walking or standing along the edge of the pavement surface;
7. A windshield survey in which distress types, severities, and quantities are estimated and recorded while riding on the shoulder at a slow speed;
8. A windshield survey in *normal traffic* in which distress types, severities, and quantities are estimated and recorded; and
9. A windshield survey at normal traffic speed in which the rater gives the pavement a general category or sufficiency rating without identifying individual distress types.

In general, the cost, accuracy, precision, and resolution decreases from 1 to 9 while the subjectivity increases. However, as long as people are performing the surveys, there is no way to completely eliminate subjectivity from the process. The same definitions of distress types and severities can be used for each method; however, the ability to identify lower severity levels decreases from 1 to 8. In addition, fewer distress types are able to be identified and recorded as the speed of travel increases. In many riding surveys, only the higher severities are included and relatively few distress types are collected. The same methods of defining quantities can also be used; however, the accuracy of quantity estimates decreases from 1 to 8. In general, when riding surveys are used, the raters are often required only to identify categories of quantities, such as 1 to 5%, 6 to 15%, etc., rather than estimate actual quantities. The sufficiency rating procedure described in 9 is generally not considered acceptable for pavement management purposes. NCHRP (27) reports that a total of 40 states still use a manual survey. Only 8 use automated procedures.

PAVEMENT CONDITION SURVEYS

Recording Distress Data: In any of the collection measures, many different methods of recording the data are available. In general, the distress data can be recorded on paper forms for later entry into the database, or the data can be entered into a portable computer. The portable computer must be hand held for walking surveys. It can be mounted in the vehicle for riding surveys. The data can be entered through a standard terminal keyboard or through a special keyboard on which distress types and severities have special keys. The data in the computers can then be transferred to the database electronically. The latest innovation is the use of electronic clipboards in which the rater writes or makes checks on the screen. Recording the data on computers decreases data entry errors because it is recorded only once; however, the agency must purchase the computers and buy, or program, the data entry programs. Reference 11 describes many different data recording procedures.

The following examples illustrate sample data collection sheets for mapping and recording distress data for the SHRP procedure (9).

PAVEMENT CONDITION SURVEYS

Figure 5.1 Sample Data Collection Sheets

State Assigned ID 1234

State Code 28

SHRP Section ID DJD1

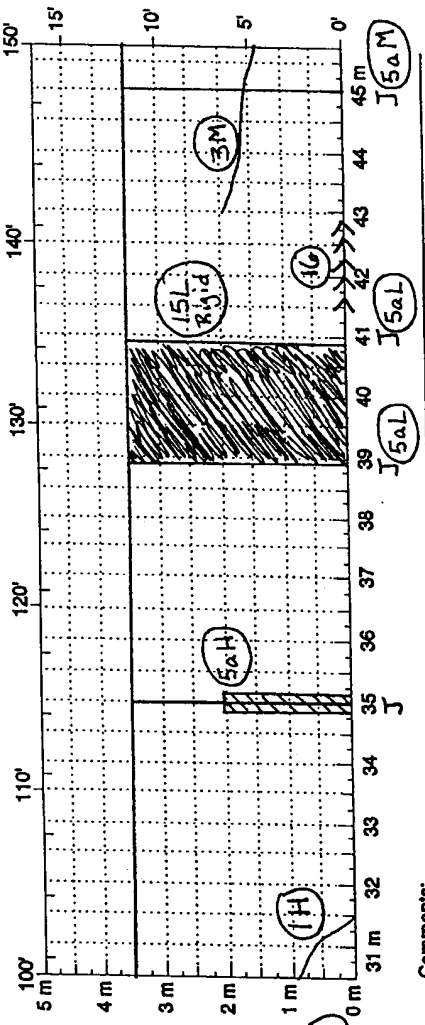

- 1H-1
- 3M-4.25
- 5aL-4
- M-2
- H-1
- 8b-2
- 15L-7 (R)
- 15M-17.5 (R)
- 16-4.5 (2)

Comments:

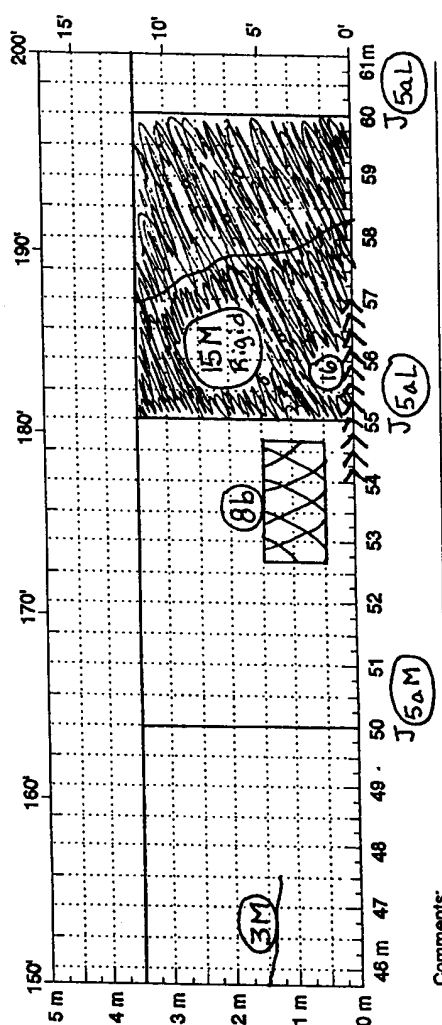

Comments:

PAVEMENT CONDITION SURVEYS

Figure 5.1 Sample Data Collection Sheets, cont.

Revised May 29, 1992

SHEET 4
 DISTRESS SURVEY
 LTPP PROGRAM

STATE ASSIGNED ID 1 2 3 4
 STATE CODE 2 8
 SHRP SECTION ID 0 1 0 1

DISTRESS SURVEY FOR PAVEMENTS WITH JOINTED
 PORTLAND CEMENT CONCRETE SURFACES

DATE OF DISTRESS SURVEY (MONTH/DAY/YEAR) 06/12/92

SURVEYORS: J S R, E J F
 PAVEMENT SURFACE TEMP - BEFORE 18 °C; AFTER 19 °C
 PHOTOS, VIDEO, OR BOTH WITH SURVEY (P, V, B) P

DISTRESS TYPE	SEVERITY LEVEL		
	LOW	MODERATE	HIGH
CRACKING			
1. CORNER BREAKS (Number)	<u>1</u>	<u>0</u>	<u>3</u>
2. DURABILITY "D" CRACKING (Number of Affected Slabs) AREA AFFECTED (Square Meters)	<u>0</u> <u>0.0</u>	<u>0</u> <u>0.0</u>	<u>0</u> <u>0.0</u>
3. LONGITUDINAL CRACKING (Meters) Length Sealed (Meters)	<u>4.8</u> <u>0.0</u>	<u>9.2</u> <u>0.0</u>	<u>0.0</u> <u>0.0</u>
4. TRANSVERSE CRACKING (Number of Cracks) (Meters) Length Sealed (Meters)	<u>1.8</u> <u>0.0</u>	<u>3.5</u> <u>3.5</u>	<u>0.0</u> <u>0.0</u>
JOINT DEFICIENCIES			
5a. TRANSVERSE JOINT SEAL DAMAGE Sealed? (Y, N) If "Y" Number of Joints	<u>8</u>	<u>4</u>	<u>Y</u> <u>2</u>
5b. LONGITUDINAL JOINT SEAL DAMAGE Number of Longitudinal Joints that have been sealed (0, 1, or 2) Length of Damaged Sealant (Meters)			<u>2</u> <u>4.0</u>
6. SPALLING OF LONGITUDINAL JOINTS (Meters)	<u>0.0</u>	<u>0.0</u>	<u>0.0</u>
7. SPALLING OF TRANSVERSE JOINTS Number of Affected Joints Length Spalled (Meters)	<u>0</u> <u>0.0</u>	<u>0</u> <u>0.0</u>	<u>0</u> <u>0.0</u>

PAVEMENT CONDITION SURVEYS

Figure 5.1 Sample Data Collection Sheets, cont.

Revised May 29, 1992

SHEET 5
 DISTRESS SURVEY
 LTPP PROGRAM

STATE ASSIGNED ID 1 2 3 4
 STATE CODE 2 8
 SHRP SECTION ID 0 1 0 1

DATE OF DISTRESS SURVEY (MONTH/DAY/YEAR) 0 6 / 1 2 / 9 2
 SURVEYORS: J S R, E J F

DISTRESS SURVEY FOR PAVEMENTS WITH JOINTED
 PORTLAND CEMENT CONCRETE SURFACES
 (CONTINUED)

DISTRESS TYPE	SEVERITY LEVEL		
	LOW	MODERATE	HIGH
SURFACE DEFORMATION			
8a. MAP CRACKING (Number) (Square Meters)			<u>0</u> <u>0.0</u>
8b. SCALING (Number) (Square Meters)			<u>1</u> <u>2.0</u>
9. POLISHED AGGREGATE (Square Meters)			<u>0</u> <u>0</u>
10. POPOUTS (Number per Square Meter)			<u>0</u>
MISCELLANEOUS DISTRESSES			
11. BLOWUPS (Number)			<u>0</u>
12. FAULTING OF TRANSVERSE JOINTS AND CRACKS - REFER TO SHEET 6			
13. LANE-TO-SHOULDER DROPOFF - REFER TO SHEET 7			
14. LANE-TO-SHOULDER SEPARATION - REFER TO SHEET 7			
15. PATCH/PATCH DETERIORATION			
Flexible (Number) (Square Meters)	<u>0</u> <u>0.0</u>	<u>0</u> <u>0.0</u>	<u>0</u> <u>0.0</u>
Rigid (Number) (Square Meters)	<u>1</u> <u>7.0</u>	<u>2</u> <u>1.3</u>	<u>0</u> <u>0.0</u>
16. WATER BLEEDING AND PUMPING (Number of Occurrences) Length Affected (Meters)			<u>2</u> <u>4.5</u>
17. OTHER (Describe) _____			

PAVEMENT CONDITION SURVEYS

Figure 5.1 Sample Data Collection Sheets, cont.

Revised May 29, 1992

SHEET 7

DISTRESS SURVEY

LTPP PROGRAM

STATE ASSIGNED ID 1 2 3 4

STATE CODE 2 8

SHRP SECTION ID 0 1 0 1

DATE OF DISTRESS SURVEY (MONTH/DAY/YEAR) 0 6 / 1 2 / 9 2

SURVEYORS: J S R, E J E

DISTRESS SURVEY FOR PAVEMENTS WITH JOINTED
PORTLAND CEMENT CONCRETE SURFACES
(CONTINUED)

13. LANE-TO-SHOULDER DROPOFF

14. LANE-TO-SHOULDER SEPARATION

Point No.	Point ¹ Distance (meters)	Lane-to-shoulder ² Dropoff (mm)	Lane-to-shoulder Separation (mm)	Well Sealed (Y/N)
1.	0.	-- 4.	-- 8.	Y
2.	15.25	-- 8.	-- 6.	Y
3.	30.5	-- 0.	-- 1 0.	Y
4.	45.75	-- 6.	-- 8.	Y
5.	61.	---	---	-
6.	76.25	---	---	-
7.	91.5	---	---	-
8.	106.75	---	---	-
9.	122.	---	---	-
10.	137.25	---	---	-
11.	152.5	---	---	-

NOT MAPPED

Note 1. Point Distance is from the start of the test section to the measurement location. The values shown are SI equivalents of the 50 ft spacing used in previous surveys.

Note 2. If heave of the shoulder occurs (upward movement), record as a negative (-) value. Do not record (+) signs, positive values are assumed.

PAVEMENT CONDITION SURVEYS

Yet another procedure for collecting data was developed by the Texas Innovation Group and distributed by the U.S. Department of Transportation's Technology Sharing Program (12).

This survey includes both a data form for recording type, severity, and extent of distress, and a scoring key for determining distress points for each distress type.

Figure 5.2 is a completed sample data form for flexible pavements. The steps required to complete the data form are:

1. Identify the distress type
2. Determine the degree (severity) of distress
3. Estimate the percentage of area affected

The distress type and severity should be determined using the standard definitions and photographs included in the manual. When the distress type and severity have been determined, the percentage of area is estimated as one of the ranges shown.

Once the distress data form has been completed, distress points are assigned to each distress type. This is done using the scoring key shown in Figure 5.3. For example, on the completed form in Figure 5.2, rutting was noted as slight and occurring on less than 15 percent of the area. From the scoring key, the distress points for this condition equal 0.

For both longitudinal and transverse cracking, the score depends on whether the cracks are sealed, partially sealed, or not sealed. The overall score for the segment is the sum of all its scores for individual defects.

The total distress points indicate the condition of one section relative to others. A higher distress point total indicates a poorer pavement. The Training Manual suggests maintenance action for any segment with a score above 10, and reconstruction of any segment with a score above 50. Your county may choose different cutoff scores.

The advantages of this method include:

- § Distress type, severity, and area are accounted for.
- § Visual inspections are used instead of detailed measurements.
- § It may be used for any size network.
- § Scoring key provides emphasis for more important distress types.

Some disadvantages are:

- § The rating scale is not 0 to 100.
- § Maintenance categories are very broad.
- § Priorities are difficult to establish.

PAVEMENT CONDITION SURVEYS

Figure 5.2 Inventory Data Form (12)

INVENTORY DATA FORM A
(Flexible Pavement)

Street Name Shakespeare Section No. 9
 From Romeo To Juliet

Types of Distress	Degree of Distress	Percentage of Area			
		1-15%	16-30%	31% -	
RUTTING <u>0</u> Score	Slight	✓			
	Moderate				
	Severe				
RAVELING <u>12</u> Score	Slight				
	Moderate		✓		
	Severe				
FLUSHING <u>5</u> Score	Slight	✓			
	Moderate				
	Severe				
CORRUGATIONS <u>12</u> Score	Slight				
	Moderate		✓		
	Severe				
ALLIGATOR CRACKING <u>15</u> Score	Slight				
	Moderate				
	Severe	✓			
TRANSVERSE CRACKING <u>7</u> Score	Slight		✓		Check One: Sealed <u> </u>
	Moderate				Partially Sealed <u>✓</u>
	Severe				Not Sealed <u> </u>
LONGITUDINAL CRACKING <u>10</u> Score	Slight				Check One: Sealed <u> </u>
	Moderate	✓			Partially Sealed <u> </u>
	Severe				Not Sealed <u>✓</u>
PATCHING <u>5</u> Score	Slight				
	Moderate	✓			
	Severe				

66
Total
Distress Points

PAVEMENT CONDITION SURVEYS

Figure 5.3 Scoring Key – Flexible Pavement (12)

SCORING KEY A
(Flexible Pavement)

Street Name Shakespeare Section No. 9
From Romeo To Juliet

Types of Distress	Degree of Distress	Percentage of Area								
		1-15%	16-30%	31%-						
RUTTING	Slight	0	2	5						
	Moderate	5	7	10						
	Severe	10	12	15						
RAVELING	Slight	5	8	10						
	Moderate	10	12	15						
	Severe	15	18	20						
FLUSHING	Slight	5	8	10						
	Moderate	10	12	15						
	Severe	15	18	20						
CORRUGATIONS	Slight	5	8	10						
	Moderate	10	12	15						
	Severe	15	18	20						
ALLIGATOR CRACKING	Slight	5	10	15						
	Moderate	10	15	20						
	Severe	15	20	25						
TRANSVERSE CRACKING	Slight	2	5	8	3	7	10	3	7	12
	Moderate	5	8	10	7	10	15	7	13	15
	Severe	8	10	15	10	15	20	12	15	20
LONGITUDINAL CRACKING	Slight	2	5	8	3	7	10	3	7	12
	Moderate	5	8	10	7	10	15	7	13	15
	Severe	8	10	15	10	15	20	12	15	20
PATCHING	Slight	0	2	5						
	Moderate	5	7	10						
	Severe	7	15	20						

S
A
M
P
L
E

S = Sealed
PS = Partially Sealed
NS = Not Sealed

PAVEMENT CONDITION SURVEYS

As was mentioned earlier, PAVER is another common distress survey procedure. PAVER is a maintenance management system developed by the U.S. Army Corps of Engineers for use on military bases. The American Public Works Association (APWA) Research Foundation offers the PAVER system complete with computer service.

The PAVER condition rating (2) is based on a pavement condition index (PCI) which is a scale from 0 to 100 that measures both the structural integrity and surface condition.

The pavement section must first be divided into samples. All samples may be inspected, or a smaller number of random samples may be chosen to represent the entire section. Statistical methods are used to determine the number of samples required.

Figure 5.4 shows a completed data sheet for concrete pavements. One data sheet is required for each sample unit.

The inspector completes the data form by walking over each sample unit and recording the measured distresses. A sketch is made of the sample unit using the preprinted dots which represent joint intersections. The appropriate number for each distress found in the slab is entered in the square representing the slab. The distress is also noted as low, medium, or high severity.

A portion of the inspection sheet is used to summarize the distress and severity levels found in each sample unit. The PCI is calculated using the following steps:

1. The deduct values are determined for each distress type and severity using deduct value curves. For example, the deduct value curve for distress No. 22, corner break, is shown in Figure 5.4. The deduct value is determined by entering the graphs at the distress density percent, which is 5, found opposite distress type 22 in the "% Slabs" column of the completed inspection sheet. Following the 5 percent line upward, it can be seen that it intersects the medium severity (M) curve at the deduct value of 8. Deduct values for all distresses are determined using the appropriate curves.
2. The total deduct value (TDV) is computed by summing all individual deduct values. The TDV is 29 in this example.
3. Once the TDV is computed, a corrected deduct value (CDV) must be determined using correction curves. The correction curve for jointed concrete pavement is shown in Figure 5.5. Notice the note that "q = number of deducts greater than 5 points." The completed inspection sheet shows two distresses, No. 22M and No.28M, with deduct values greater than 5. The CDV is determined by entering the graph at TDV = 29 and moving upward to the intersection of the q = 2 curve. This corresponds to the CDV value of 24 as shown on the completed sample.
4. The PCI is $100 - 24$ or 76.

Figure 5.4 Completed Jointed Concrete Sample Unit Inspection Sheet (2)

FORM A CONCRETE PAVEMENT INSPECTION SHEET

BRANCH MARSHALL AVE. SECTION 1
 DATE 10/3/79 SAMPLE UNIT 1
 SURVEYED BY SK SLAB SIZE 15 x 20

Distress Types				
21. Blow-Up	31. Polished			
Buckling/Shattering	Aggregate			
22. Corner Break	32. Popouts			
23. Divided Slab	33. Pumping			
24. Durability ("D") Cracking	34. Punchout			
25. Faulting	35. Railroad Crossing			
26. Joint Seal Damage	36. Scaling/Map Cracking/Crazing			
27. Lane/Slidr Drop Off	37. Shrinkage Cracks			
28. Linear Cracking	38. Spalling, Corner			
29. Patching, Large & Util Cuts	39. Spalling, U Joint			
30. Patching, Small				

DIST. TYPE	SEV.	NO. SLABS	% SLABS	DEDUCT VALUE
26*	M	/	/	4
22	L	1	5	4
22	M	1	5	8
28	L	1	5	3
28	M	2	10	9
38	L	2	10	1
DEDUCT TOTAL $Q = 2$				29
CORRECTED DEDUCT VALUE (CDV)				24
PCI = 100 - CDV = <u>76</u>				
RATING = <u>VERY GOOD</u>				

* All Distresses Are Counted On A Slab-By-Slab Basis Except Distress 26, Which Is Rated For The Entire Sample Unit.
 ** Total Number of Slabs Containing Each Distress of Same Severity

Figure 5.5 Deduct Value Curve

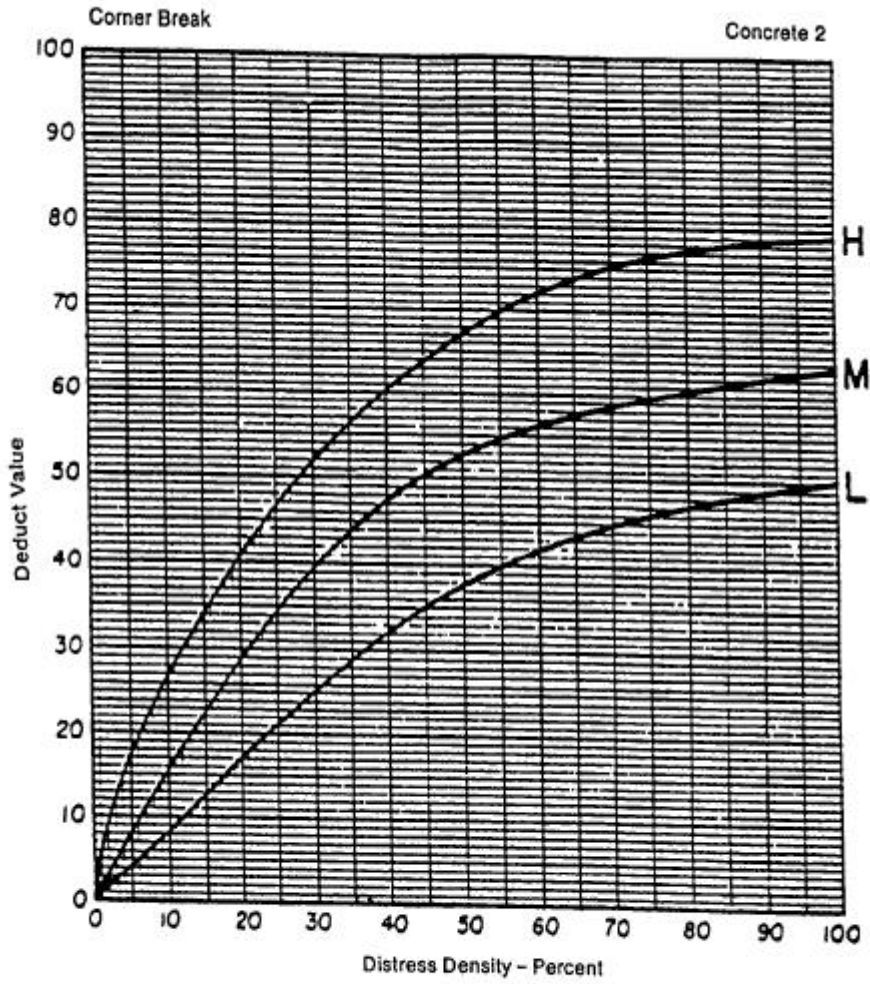
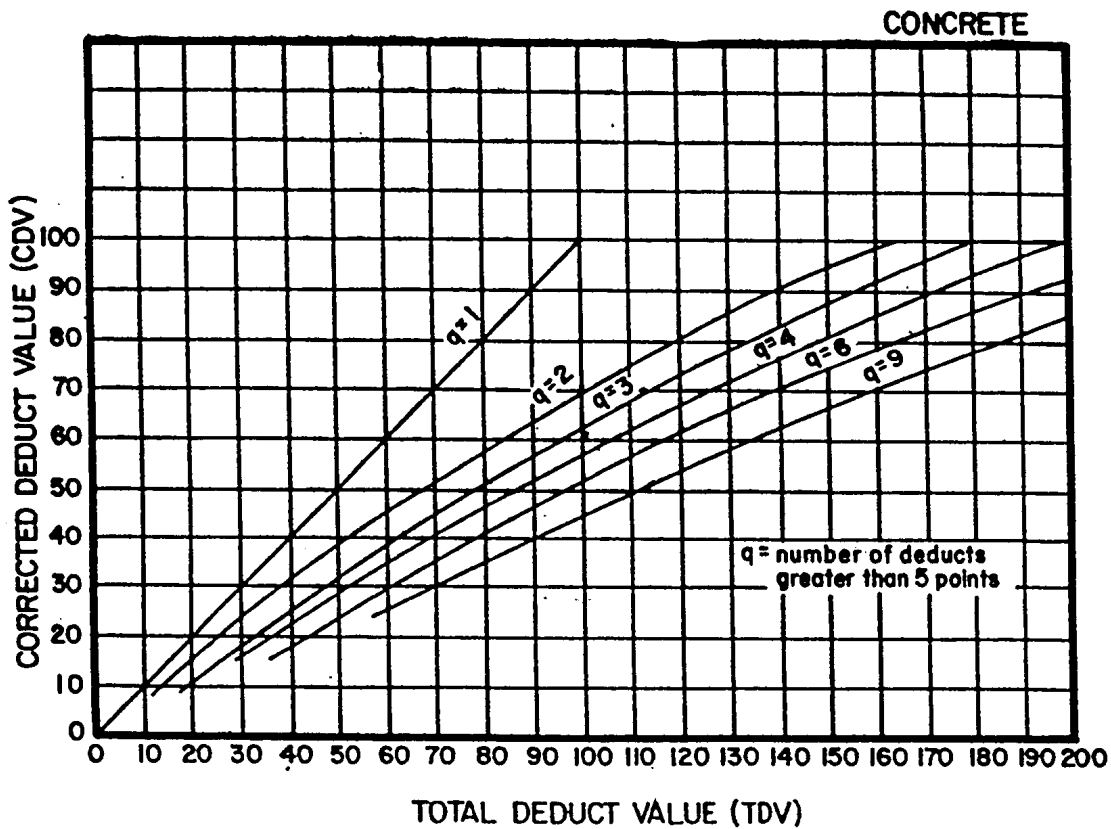

Figure 5.6 Correction Curve for Jointed Concrete Pavement



PAVEMENT CONDITION SURVEYS

The PAVER system has proven effective on military installations and in several cities throughout the country. However, its use by local governments has some disadvantages. Among them are:

- § Sections must be divided into sample units. Each sample unit requires one data form. This greatly increases the volume of records for manual systems.
- § Each distress in each sample unit must be physically measured. This greatly increases inspection time and costs.
- § The number of units to be inspected is based upon statistical samplings. If the range of PCI's within a section varies greatly, additional units will have to be inspected, and second or even third field inspections may be necessary.
- § The PCI computation may become tedious for a large network.
- § For even small networks, manual systems may not be practical.

PAVER has the advantage of being a rather precise distress survey technique which produces consistent results when repeated. The rating procedure produces a meaningful and very accurate measure of pavement condition. PAVER also has the advantage of being supported very actively by the APWA.

Training Raters: For any given method of distress data collection, the accuracy and precision are a function of the training of the data collection personnel, the clarity of distress identification manuals, and the quality control practiced by the agency. The distress identification manuals must be clear so that the rater always has a standard to which to refer. A clear manual and comprehensive training reduce subjectivity. Reference 6 is an example of a distress identification manual used in many agencies across North America.

In most agencies, inspectors only collect distress data a few weeks each year. Annual training sessions are necessary before each distress collection period, even for those who have inspected pavements before. Inspectors are more accurate if they know their work is going to be checked. In general, a quality control program should be established in which a small percentage of the pavements inspected are re-inspected by supervisory staff or other inspection teams. Three to five percent is often used. If the inspections between teams diverge, the inspectors should be put through a refresher training course.

Typical Manual Walking Survey Procedures: In walking surveys, pavement inspection is typically conducted on selected inspection units in the management section. An inspection unit is a small segment of a management section selected of convenient size that is then inspected in detail. SHRP uses inspection units, 120 m long by one lane wide. Typical agencies would use inspection units from 50 to 200 feet (15 to 60 m) long by one to four lanes wide. Generally, inspection units should have a relatively uniform size within a management section. Most states such as Iowa, New Mexico, and Pennsylvania, still use some form of manual surveys. As stated earlier, 40 states still reported using manual or windshield surveys in 1994 (27). However, in recent years, more states are beginning to move towards automated surveys.

The units inspected may be selected at random or through a defined sampling procedure. Some agencies select inspection units to "represent" the section, whereas others select inspection units at a set frequency, e.g. one every quarter kilometer.

PAVEMENT CONDITION SURVEYS

The inspector then inspects the sample unit by walking the pavement. The inspection can be completed while standing on the shoulder. The inspector identifies and records each distress type, severity and amount present in the inspection unit. The type, severity and amount must correspond to those defined in the appropriate distress identification manual. The quantities and severities should normally be estimated using measuring techniques as accurate as measuring wheels or tapes to pacing.

Data may be recorded using a hand held microcomputer, a pen based computer (electronic clipboard), or a data collection sheet. The total quantities for each distress type and severity are automatically tallied in the data collection devices. The inspector must sum them after returning to the office if data collection sheets are used.

Typical Windshield Survey Procedure: The windshield survey is conducted from a moving vehicle. Reference 13 is an example of such a survey. The inspector travels the road management section in a vehicle travelling at about 5 to 15 miles (8 to 20 km) per hour. The distresses are visually identified by the rater, and the area affected is estimated as a percentage of the road surface (13).

Five distress types, drainage and roughness are rated by the inspector. Alligator cracking, edge cracking, and longitudinal/transverse cracking are each rated with three severity levels and three levels of extent (quantity). Patching/potholes are rated with three levels of extent but without considering severity. Rutting is rated with two levels of severity but without information on quantity. Roughness and drainage are related with three severity levels without information on quantity.

The damage quantities are estimates of the percentage of the entire management section affected and are generally in categories such as (13):

- | | |
|----------|--|
| Low | the total section length affected is less than 10% of the section length |
| Moderate | the total section length affected is between 10% and 30% of the section length |
| High | the total section length affected is more than 30% of the section length |

The information is determined as the inspector travels along the road on a single management section and is recorded on a data collection sheet, digitizing tablet, or laptop computer. At the end of the management section, the data must be finalized by completing the data collection sheet or storing the collected data in the lap-top computer.

The collection of distress data using quantity categories limits the use of the data. The change in quantities will not be a smooth function over time. Instead, the change in quantity over time will be a step function, and it often may jump back and forth between categories when the quantity is near a limit of the category, e.g. when the quantity is near 10 or 30% in the example shown above. This can lead to instability in the data over time.

AUTOMATED DISTRESS SURVEYS: Manual distress survey procedures are slow, labor intensive, and subject to transcription errors. Consistency between classification and quantification of the distresses observed by different raters can also be a problem. Once the data has

PAVEMENT CONDITION SURVEYS

been summarized and corrected for transcription errors, the only recourse for checking apparent anomalies in the data is a return visit to the field. Safety of field crews is also another concern.

To minimize these problems, methods have been devised by various agencies to standardize distress classifications and to speed up the survey process by automating the recording, reduction, processing, and storage of the data. Small hand-held computers and data loggers have been used.

Vehicles, which take photographs or other visual images of the pavement, have been developed to speed the field data collection time and provide a permanent visual record of the actual pavement condition. A new class of condition survey vehicles is emerging which uses objective measures of the pavement surface to classify and quantify different types of distress. The direction of current development in distress survey equipment is the use of video imaging to take a picture of a portion of pavement and, by using pattern recognition technology, classify and quantify distress directly without the subjective evaluation of human raters.

An automated distress survey can be classified as any method in which distress data is entered directly to the computer in the field during the distress survey. This type of automation can greatly reduce errors associated with transcribing data from paper forms as collected in the field into computer files which will be used in road surface management. Other benefits of automated distress surveys include increased safety for survey crews, faster and more accurate surveys, less expensive data collection, and more repeatable surveys.

As mentioned above, imaging and distance measuring techniques are being developed to measure distress (3,4,14). There are several classes of automated data collection and interpretation as summarized below:

1. Distress images are collected on film or high resolution video, image analysis techniques are used to identify type, severity, and quantity of individual distress types while the vehicle collects the data;
2. Distress images are collected on film or high resolution video, image analysis techniques are used to identify type, severity, and quantity of individual distress types in the office after the vehicle collects the data;
3. Distress images are collected on film or high resolution video, a trained observer is used to identify type, severity, and quantity of individual distress types in the office while viewing the images after the vehicle collects the data;
4. Lasers are used to determine changes in surface texture and distance which are interpreted to determine some distress types by computer algorithms;
5. Lasers or other methods are used to measure distance to determine specific distress types such as rutting in asphalt concrete pavements.

In general, as the survey type increases from 1 to 3, the subjectivity increases. The resolution is a function of the equipment used to make the image. In general, 35 mm photography has higher resolution, but it must be digitized for image analysis by

computers. Resolution in photography is a function of the film speed, coverage area, and lighting. Video is basically a digitized format when the image is made, and resolution is a function of the number of pixels per distance, the shutter speed, and lighting. The resolution of the laser equipment is a function of the size of the laser point and the analysis algorithm used to convert changes in texture to distress.

Item 5 above recognizes that it is possible to use special equipment to measure certain types of distress. The "rut bar" is the most commonly used. A series of distance measuring devices are placed on a horizontal bar. The differences among the measurements of the devices are used to develop a transverse profile of the pavement surface from which the amount of rutting can be determined. In item 5, the resolution is a function of the number of distance measuring devices and the precision of the distance measuring process. The precision is a function of the number of measuring devices and the location differences between repeat runs.

The precision and accuracy are functions of the interpretations, the lighting, and the placement of the imaging during repeat runs. The laser-based systems have more precision problems because they view small areas which are combined to give estimated distress information. If a repeat run is a few millimeters (inches) off from the location of the first run, the information can be quite different.

For the imaging systems, the images can be affected by shadows from trees, poles, etc. The direction of the sun can also change the image from one time of day to another. Any of the approaches can control the lighting conditions either by enclosing the camera and pavement with fixed lighting or by completing all surveys at night and using fixed lighting. The lights can be set at an angle so that known shadows can be used to help identify crack widths, elevation differences, etc.

One of the selling points for using automated distress survey procedures is that they are less subjective than manual surveys. However, the subjectivity is a function of the type of interpretation. In the simplest form, the images are manually interpreted. The distress identification is still manual; the inspector identifies, quantifies, and records distress from the image rather than from the pavement surface directly. This takes the inspector off the road and reduces traffic interruption, both of which are extremely important for safety on high volume highways, but subjectivity is still present.

The least subjective system is the automated analysis of the images. However, image analysis by automated means has been found to be quite complex. The distresses can take many patterns. This requires pattern recognition algorithms that can distinguish between types of cracks, between a patch and pavement markings, etc. Some distresses such as weathering and raveling do not appear on images very well and must be interpreted based on surface texture or other approaches. The pavement surface texture varies considerably between pavement surface types which must be considered in the interpretation. The fact that colors of pavement surfaces vary considerably must also be considered. All of this has prevented any of the systems from completing a fully automated interpretation process at the time this was prepared.

PAVEMENT CONDITION SURVEYS

At the current time, any distress information collected and reduced using automated procedures needs to be carefully analyzed to determine the accuracy, precision, and resolution.

The exception to this is the measurement of rutting with distance measuring equipment, often referred to as “rut bars.” These devices are generally quite accurate, are capable of collecting data more often than could normally be collected manually, and give information in a quantitative form ready to use.

5.6 Automated Condition Survey Equipment

Most states use automated equipment to collect pavement friction, roughness, profile, rut depth, and deflection data. Most still perform visual distress surveys but this process will change drastically in the 1990’s. Table 5.6 contains a list of the primary devices used to collect these indicators. Table 5.7 lists equipment used since the 1940’s, devices used today, and projected equipment beyond the year 2000.

TABLE 5.6 Summary of Primary Condition Data Collection Equipment Used By the States.*

DEVICE	FRICTION	ROUGHNESS	PROFILE	RUT DEPTH	DISTRESS	DEFLECTION
Locked Wheel	Most all					
Mays/Cox		18				
KJ Law 8300/690		9	9			
ARAN		6		5	5	
Laser RST		2	2	2		
SD Road Profiler		24	24	24		
Dynalect						6
Road Rater						13
FWD						32

*The 50 States, the District of Columbia and Puerto Rico.
 Note: Totals exceed 52 in some cases due to concurrent data collection for the purpose of correlating data collected with a new device to the historical database. Totals may also be less than 52 if automated equipment is not used.

PAVEMENT CONDITION SURVEYS

Table 5.7 Automated Pavement Condition Data Collection Trends in Technology

TIME PERIOD	FRICTION	ROUGHNESS	PROFILE	RUT DEPTH	DISTRESS	DEFLECTION
Pre 1940	Subjective ↓	Subjective ↓	NM ↓	Subjective ↓	Subjective ↓	NM ↓
1940 to 1960	LW ↓	RTRRMs ↓	NM ↓	Manual ↓	Subjective ↓	Static ↓
1960 to 1980	LW ↓	Many RTRRMs → ↓ Profilers ↓	A few ↓ Profilers ↓	Manual ↓	Subjective ↓ & Manual ↓	Steady State ↓ Dynamic ↓
1980 to 1990	LW ↓	RTRRMs & ↓ More Profilers	Increasing No. ↓ of Profilers ↓	Manual, Laser ↓ Acoustic ↓	Subjective, Acoustic ↓ Laser & Video ↓	Steady St. Dyn. → ↓ Impulse ↓
1990 to 2000	LW → Video ↓ &/or Laser? ↓	Mostly Profilers ↓	Profilers ↓	Acoustic & ↓ Laser ↓	Video & Image ↓ Processing ↓	Impulse ↓
Beyond 2000	Laser or Video?	Profilers	Profilers	Laser or Video?	Image Processing & Pattern Recognition	Laser or Video?

LW = Locked Wheel Skid Trailer RTRRMs = Response Type Road Roughness Meters NM = Not Measured
 Predicted use based on information received from state PM practitioners, researchers, and equipment suppliers (shaded).

DISTRESS: Most State Highway agencies still use a visual survey as the basis for distress data collection. The manual process, however, will be transformed to a highway-speeds data collection process during the 1990's. The subjective visual distress survey has been enhanced considerably by the addition of condition survey keyboards. The keyboards permit the rapid entry of large quantities of data, and eliminate transcription errors since data is uploaded electronically to the central database.

Several technologies hold great promise for accomplishing high-speed distress data collection: laser technology, film-based systems, and video systems. Laser systems detect some cracking, but reliability and repeatability is poor. In addition, no visual record of the condition is available. Film-based systems such as the PASCO Road Survey System (Figure 5.7) being used by the Strategic Highway Research Program provide very highly resolved, proportionally scaled images of the pavement surface. Other agencies using the PASCO system are the Arizona, Connecticut, Illinois, and Iowa Departments of Transportation.

Figure 5.7 PASCO Road Survey System

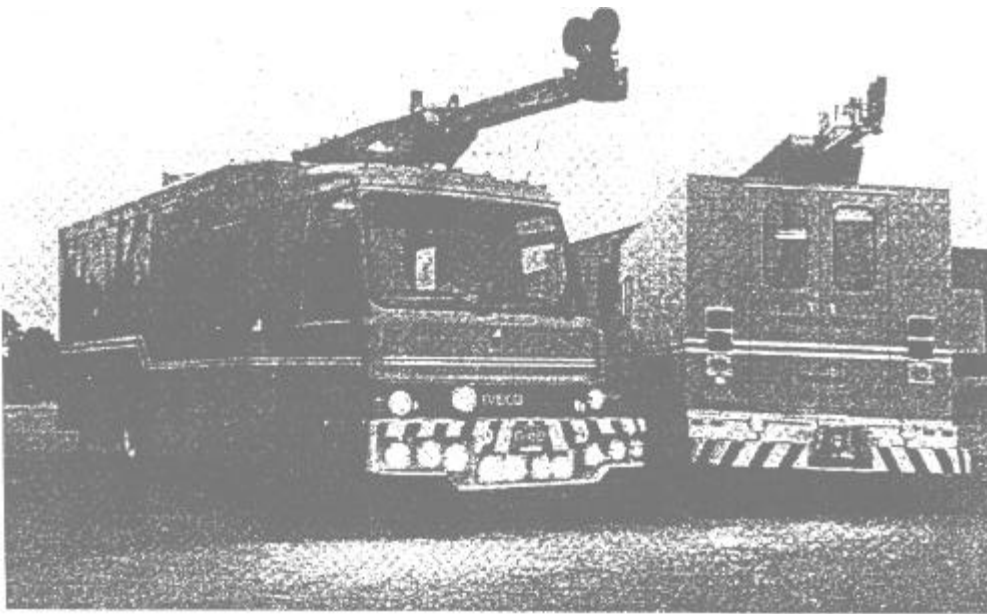

The PASCO 35-mm film technology produces a continuous film of the pavement that can be readily digitized with automated equipment. The system operates at night using external illumination to emphasize distresses on the film. Widths of up to 16 ft. can be photographed with the system. In the office the strip film is processed, and distresses are manually measured on a film digitizer. Any type of distress on any type of pavement can be determined. A similar system, the GERPHO has been used in France since the mid-1970's.

PASCO has developed a system to measure rut depth and transverse profile across a full lane width. A rear-mounted camera photographs a hairline projected on the pavement surface by a pulsing strobe light. (Figure 5.8). Measurement intervals can be programmed by the operator. Fifty-foot intervals are usually selected. The photographed hairline parallels the pavement surface. Using the fixed geometric configuration of the camera and strobe projector the rut depth can be accurately measured in the office. Excellent correlation between manual measurements and the PASCO process have been recorded.

PAVEMENT CONDITION SURVEYS

Figure 5.8 PASCO Road Survey System Rut Depth Measurement

Rut Depth Field Data Collection

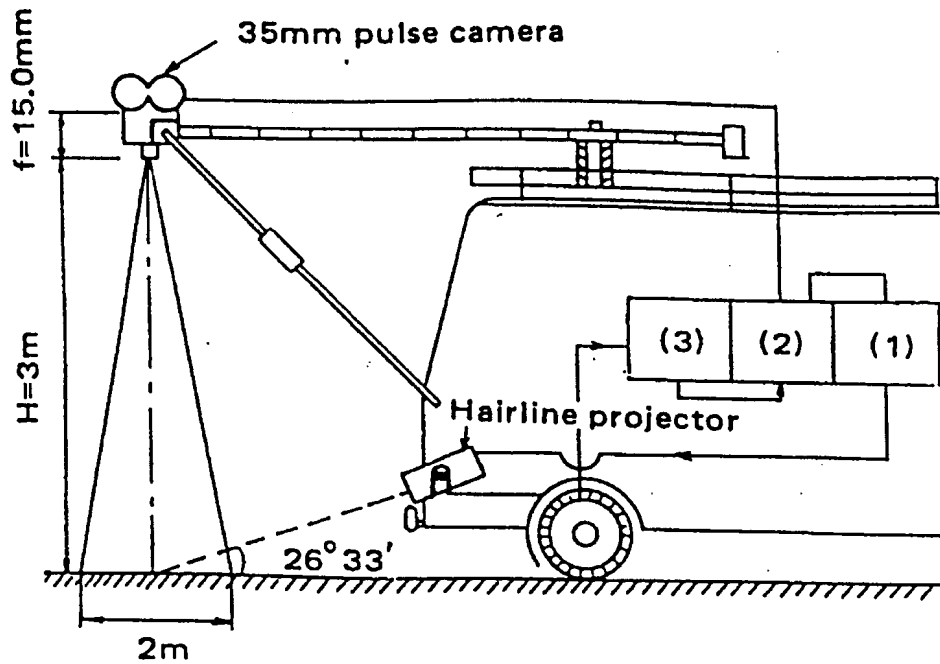

- (1) Hairline projector control unit
- (2) Camera control unit
- (3) Pulse signal transmission device

Figure 5.8 PASCO Road Survey System Rut Depth Measurement, cont.

Filmed Rut Depth - Hairline Images

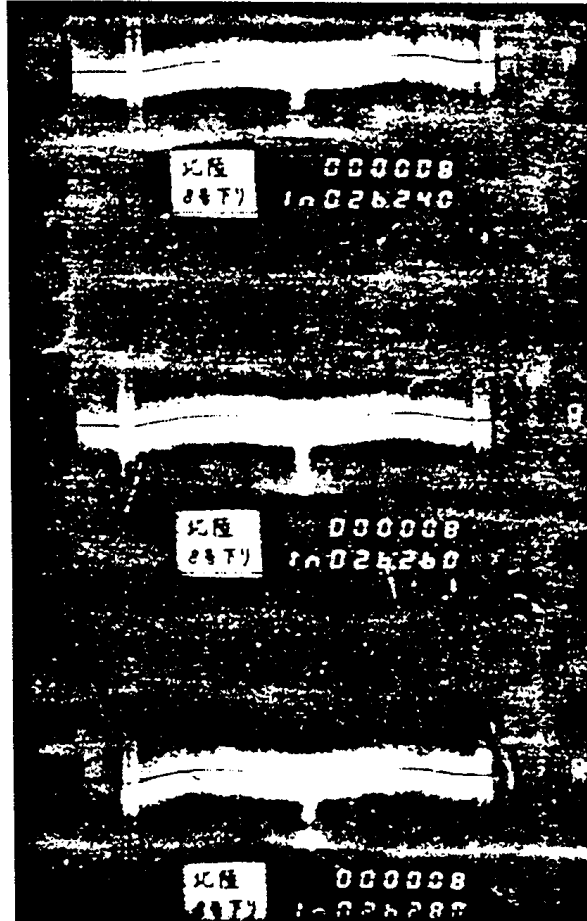

The cost of the PASCO system exceeds most state's budget for network level surveys. Video systems hold great promise as a low-cost, reusable substitute for film, and eliminates film development.

The ARAN, the Australian Road Evaluation Vehicle, the MHM Associates ARIA system, Pavedex's PAS-1 device, the PaveTech VIV unit, and the VideoComp trailer use videos to record pavement images. The Roadman-PCES system uses a line camera and slightly different process. Depending on the device 1,2,3,4, or 5 cameras record surface distresses. Multiple camera installation permits detection of 1/8" or finer pavement surface cracks. Table 5.8 compares the relative cost and resolution of various image media.

PAVEMENT CONDITION SURVEYS

Table 5-8 IMAGE MEDIA COMPARISON

MEDIA	RELATIVE COST	LINES OF RESOLUTION
35 mm Film	High	1700 – 3500+
VHS	Low	250+
³ / ₄ - inch Video Tape	Low	340+
S-VHS	Low	400+

The ARAN is a high speed, multi-functional, and diverse road/infrastructure data acquisition vehicle. It has the capability to measure pavement condition and distresses required for comprehensive pavement management. User agencies of the ARAN include state, county, and city transportation departments in over 20 countries worldwide, 30 states within the United States, and 7 of the 10 Canadian provinces.

Two different onboard geometric subsystems are employed. The Standard Onboard Geometrics and Orientation System employs three aircraft gyroscopes and accelerometers that continually measure the roll, pitch, and heading of the ARAN. The POS/LV Onboard Geometrics and Orientation System utilizes state-of-the-art military aircraft grade gyroscopes, accelerometers, and Global Positioning System (GPS) receivers all working in concert to provide enhanced survey level precision measurements. The ARAN employs GPS to continuously monitor the ARAN’s absolute position in XYZ space with an accuracy of 50 to 100 meters.

ARAN employs two road roughness profile measuring systems. The Laser SDP employs the use of lasers instead of ultrasonic sensors. The second road roughness profile measuring system is an inertial roughness profilometer. The ARAN also used a “Smart Bar” for road rutting measurements. The “Smart Bar” employs up to 37 ultrasonic sensors positioned at four-inch intervals across the entire transverse profile of a 12-foot lane. The rut is then measured to an accuracy of 1/32 of an inch. Most states owning an ARAN measure rut depth using 13 sensors, obtaining a transverse point every 12 inches.

Video logging is used to collect data. The ARAN can employ up to six video cameras. The two onboard video logging subsystems are the Right-of-Way (ROW) windshield video and the Pavement View (PV) video. The ROW consists of a full color video camera mounted between the driver and passenger and looks forward out of the vehicle’s front window to record a continuous video as seen through the windshield.

Figure 5-9 The Automatic Road Analyzer (ARAN)

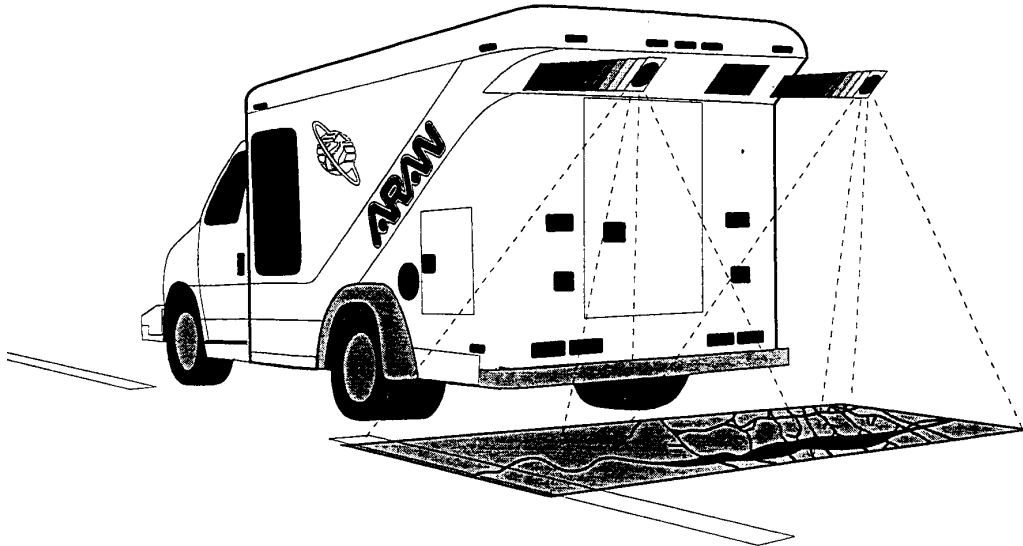

MHM Associates are the suppliers of the Automated Road Image Analyzer, *ARIA* (Figure 5.10). The *ARIA* has the capabilities of measuring both pavement distress and rut depth. The user vehicle for the *ARIA* is generally a van, which can operate at speeds of 10 – 50 mph. The system components consist of a video camera to collect data, a distance measuring instrument (DMI) for data referencing to an accuracy of 1/100 of a mile, and automated digitized processing through video imaging to analyze acquired data. The minimum size crack that *ARIA* can detect is 1/8 – 1/16”.

Currently, the *ARIA* is used primarily at the local level, such as the City of Corisicana, Texas, and LaPorte County, Indiana.

Figure 5.10 MHM Associates, ARIA

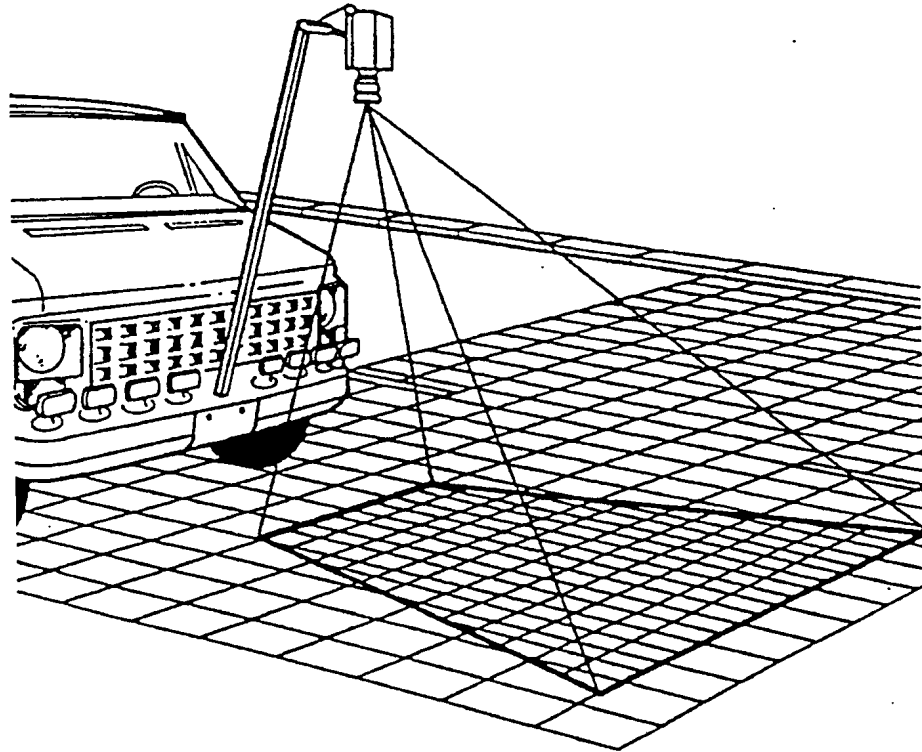

Pavedex Inc. is the supplier of the *PAS-1*, another automated pavement distress collector (Figure 5.11). The user vehicle for the *PAS-1* is a van that has the capacity to operate at speeds from 0 to 55 mph. The system components consist of five video cameras, 2 on the front, 2 on the rear, and one top center mount. Each camera can cover a span of 30 square feet, with a 50% overlap at 55 mph. The cameras record pavement distress and the system utilizes automated digitized processing through video imaging to determine cracks with a width as small as 1/16". The DMI used in the *PAS-1* can measure with an accuracy of one foot. The *PAS-1* also employs a road videolog, which is suitable for inventory of signs, as well as roadside and condition monitoring.

The Pavedex *PAS-1* is currently being used in 10 counties and 4 cities in the western United States. Evaluations have been completed by Caltrans, Washington DOT, Iowa DOT, and the Kansas DOT.

Figure 5.11 Pavedex PAS-1



PaveTech Inc. is the manufacturer of the *PaveTech Video Inspection Vehicle (VIV)* shown in Figure 5.12. The *PaveTech VIV* is an automated pavement distress collector that utilizes five video cameras, similar to Pavedex's PAS-1, to measure pavement distress, roughness, rut depth, and road profile. The user vehicle is a van, which operates at speeds from 0 to 60 mph. The system components consist of the cameras, accelerometer(s), ultrasonic sensors, and a DMI with an accuracy of less than 0.5%. *PaveTech VIV* uses this equipment to measure cracks with a width greater than or equal to 1/16", produce the roughness in IRI, the PSI, the rut depth profile, distress in three dimensions, and a raw distress database.

Figure 5.12 PaveTech VIV

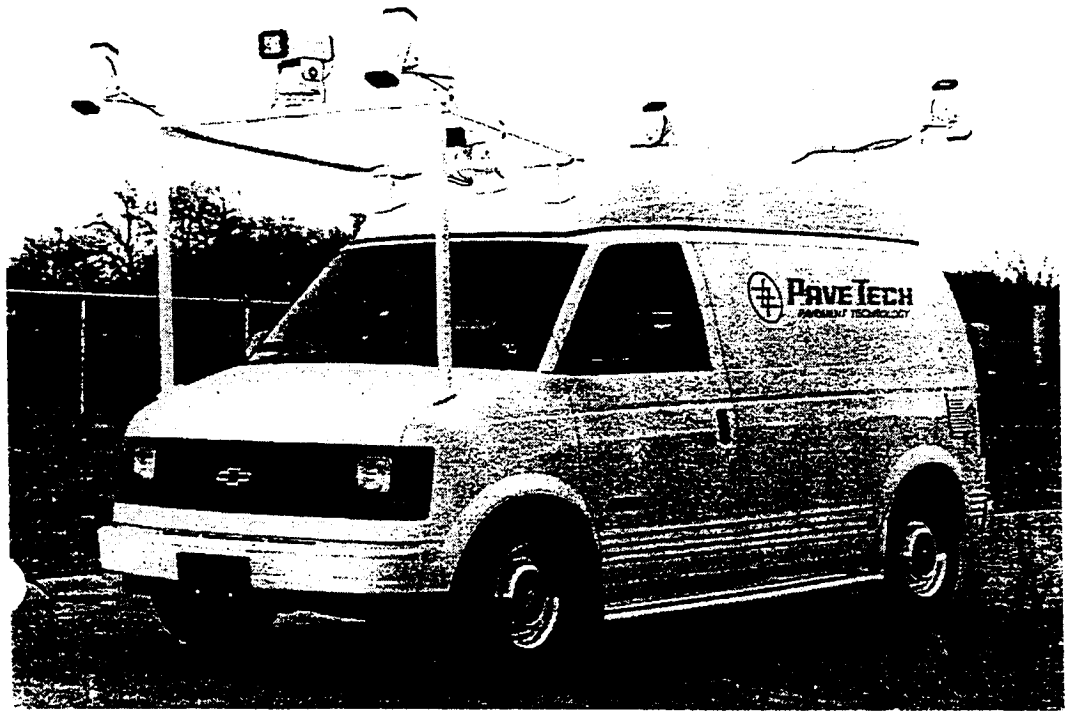

VideoComp (Figure 5.13) is a automated data acquisition vehicle that measures pavement distress. It is contained in a trailer that is towed behind a suitable vehicle at speeds of up to 60 mph. The data is collected through the use of 4 video cameras, which have the capability to measure cracks with a minimum width of about 1/10". *VideoComp* uses four 500-watt lamps adjacent to the cameras that are mounted in the trailer to provide additional lighting. It also utilizes a monitor that checks all cameras during data collection. The output from *VideoComp* is a crack map that illustrates the location and extent of cracking on the road.

Figure 5.13 VideoComp Trailer

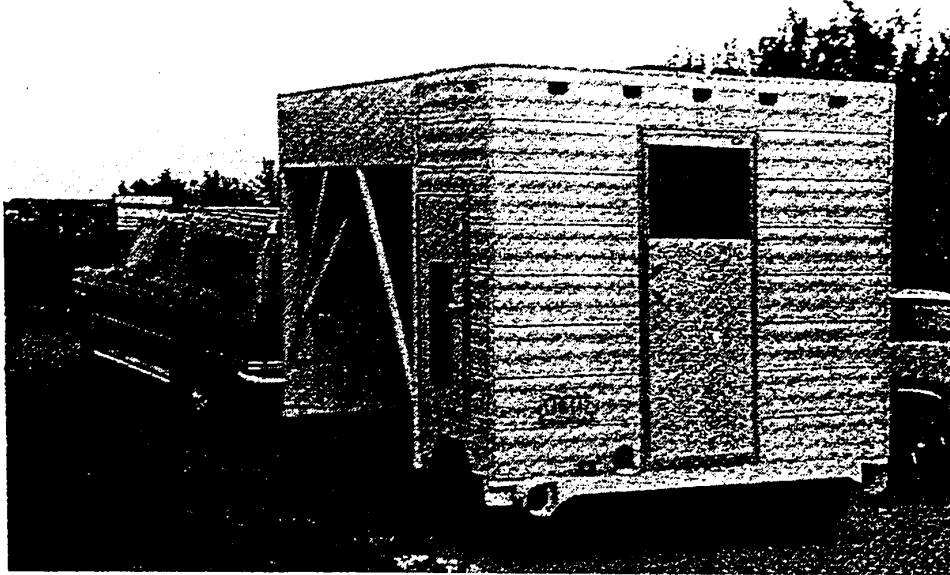

Roadman-PCES Inc. is the manufacturer of the *Pavement Distress Imager (PDI-1)*, illustrated in Figure 5.14. The *PDI-1* uses a step van on a 21-foot Grussan truck body, operating at speeds of 0 to 60 mph, to record pavement distress through a continuous line scan videolog. The *PDI-1* measures pavement roughness through the use of a ultrasonic transducer and a linear accelerometer. It has the capacity to measure crack widths as small as 1/20”.

Figure 5.14 Roadman-PCES

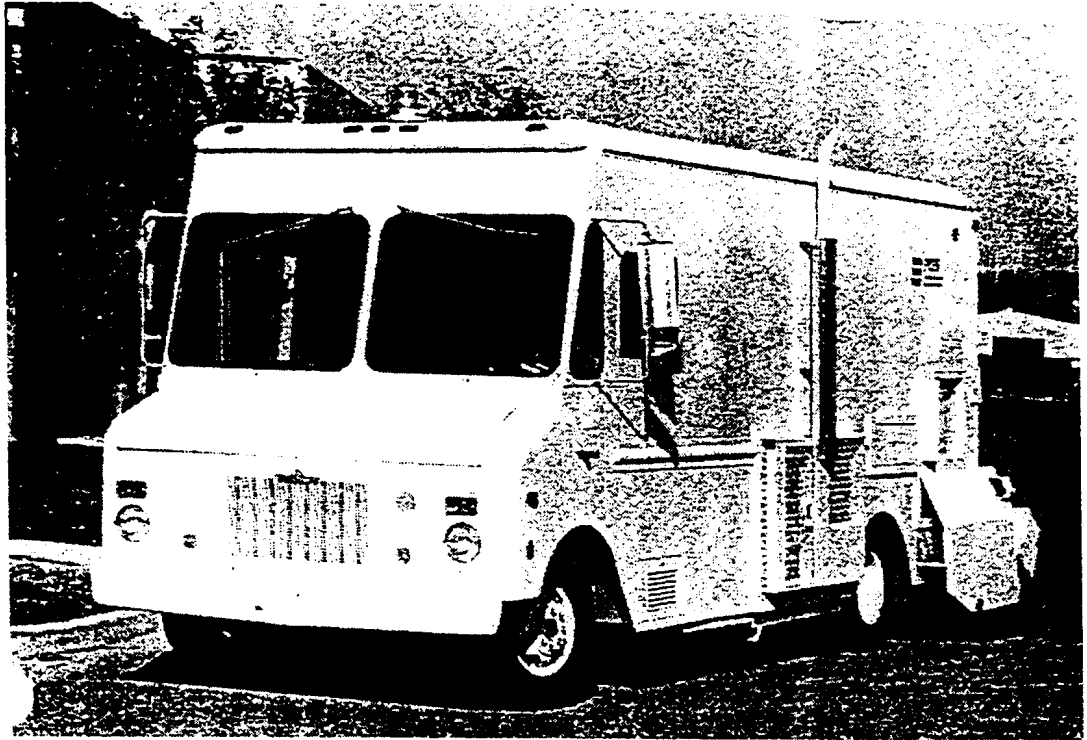

The following equipment measure rut depth and/or surface roughness.

The *ITX Stanley Road Tester 3000* is a pavement survey device housed in a standard van, or similar vehicle, that surveys distance, longitudinal profile, roughness, pavement surface distress, and rut depths. It incorporates image capturing and global positioning and is typically operated at speeds of up to 50 mph.

A transmission driven DMI is used to measure distance along the traveled pavement section. The DMI transducer produces electronic pulses at a set frequency and operating software translates the signals into a traveled distance and records it as a reference point for data being simultaneously measured/collected by each of the other operating subsystems.

PAVEMENT CONDITION SURVEYS

The *RT 3000* measures longitudinal profile and roughness through the use of 3 transducers; a height sensor which measures the distance between the vehicle and the pavement surface while the vehicle is traveling at up to posted speed; an accelerometer which measures the vertical accelerations of the vehicle as it bounces in response to the pavement surface profile; the DMI to provide a reference measurement of the vehicle as it traverses the road. Operating software and post processing software combine the three measurements, eliminating the effects of vertical vehicle motion and thereby defining the vertical profile of the pavement surface. The longitudinal roughness profile of each wheel track is obtained using an accelerometer and height sensor in each wheel track.

The *RT 3000* also employs a surface distress recording subsystem. It includes specially designed data entry keyboards to automate the entry into the central computer of observed surface distresses. The system identifies a wide range of distress manifestations, identifies the severity in three classifications (low, moderate, and severe) and quantifies them in a number of area coverage categories.

Rut measurements are conducted using a 5-sensor rut bar mounted in the front bumper position on the survey vehicle. One sensor is placed in the center of the vehicle, one sensor mounted in each wheel path, and one sensor placed outside each wheel path. This configuration enables the calculation of each wheel track rut separately.

There is also a video-based system consisting of two or three cameras and two super VHS video recorders. The cameras can be mounted facing downward, capturing an image of the pavement surface, and facing forward, capturing the street-scope from which the right-of-way data can be extracted. The *RT 3000* uses a Global Positioning System (GPS) to collect the position coordinates of any roadway feature of interest and record its detailed attributes.

The *Laser RST* is a multi-function testing vehicle that was developed in Sweden and is used by Infrastructure Management Services (IMS) in North America. The *Laser RST* uses laser technology to identify the distress, profile, roughness, rut depth and macrotexture of a pavement. The system consists of video cameras, accelerometers, laser sensors, a distance measuring instrument and a computer system. The system uses 11 laser sensors to collect data. Four of the sensors are used for identification of cracks and the remaining sensors are used to collect information on rutting and microtexturing. The data can be collected for small sections, such as block by block, or for long stretches of roadway. The information is collected and is stored in a data file. The data file is then imported into a software program that is developed for each agency based on the protocol specified. The system also has the capability to calculate an IRI for the pavement in real time. The vehicle has the option of being equipped with a GPS system.

The *GIE System* (GIE Technologies) performs a detailed assessment of the current state of the road network and its weaknesses, provided by state-of-the-art instrumentation loaded on board a specialized vehicle traveling at the speed of regular traffic. The specially fitted vehicle is equipped with a laser system, called BIRIS, which captures data on the roadway surface conditions, such as ruts and cracks, and the

PAVEMENT CONDITION SURVEYS

longitudinal and transverse profiles of the road surface. In addition, the vehicle may be equipped with a stereoscopic imaging system for roadway features, a georadar system to capture data on the condition of sub-surface structure layers and an infrared camera to detect problems with the adherence and lamination of multiple surface materials and bridge sections. The vehicle is also equipped with a GPS system for automatic positioning of roadway data.

The BIRIS laser beam technology is a telemetric and photometric sensor using laser beams to collect information. Using the dual irises in the sensor's optical system, the technology generates calculations of the distance to an object intersected by the laser light beams. Using a set of six sensors, the vehicle is equipped to inspect surfaces measuring up to 3.6 meters (12 feet) in width.

The *GIE System* generates continuous measurement of various parameters including: roughness of the surface using IRI international standard; type severity and extent of defects in three dimensions, using SHRP and MTQ (Ministere des Transports du Quebec) standards; continuous longitudinal profiles in both wheel paths; transverse profiles acquired at regular intervals across the path of travel; positioning and measurement of ruts; cracks and other defects; reconstitution of defects in three dimensions; classification of quantitative information; digitized photometric image of the roads surface; and characterization of the road surface geometry (gradient and crossfall).

A comprehensive analysis of the data is provided by a highly specialized management program called PEAK. The information collected by the laser, georadar and infrared camera on the defects on the road surface and structure are processed and classified by a computer on board the vehicle. Subsequently, compressed and archived data are analyzed by the PEAK software, which extracts relevant information. PEAK conducts a preliminary diagnosis and identifies the causes and processes of road deterioration.

Another automated pavement distress collection system is the *Road Surface Analyzer (ROSAN)*. The *ROSAN* series made its debut in 1997 after being developed at the FHWA's Pavement Surface Analysis (PSA) Laboratory at the Turner-Fairbank Highway Research Center (TFHRC).

The *ROSAN* devices electronically record macrotexture characteristics of pavement surfaces, some at highway speeds. It incorporates a laser sensor, accelerometer, and distance pulser in a unit mounted on wheels. The *ROSAN* comes in four models, each with different operating characteristics:

The *ROSAN_{bp}* is the first in the series and has two modes of operation. In the (b) mode, a computer-controlled trolley carries the laser sensor across a stationary 1-m reference beam. In the (p) mode, the entire unit is manually pushed or pulled. Outputs include macrotexture, grooving, and faulting.

The *ROSAN_v* incorporates a laser sensor is mounted on a vehicle bumper and can be operated up to speeds of 60 mph. Data can be recorded continuously for distances of 800 to 2300 feet, depending on data collection mode. The unit can be mounted on

PAVEMENT CONDITION SURVEYS

almost any vehicle fitted with a simple bumper-mounted trailer hitch. Outputs include macrotexture, faulting, and grooving.

The *ROSAN_{vm}* uses a computer-controlled motorized trolley that guides a laser sensor along a beam that is mounted on the front of a suitable vehicle. The beam can be one of three lengths and operated up to speeds of 60 mph. Outputs include left wheel path, center, and right wheel path macrotexture and faulting, grooving, rutting and slope.

The *ROSAN_{vm(P)}* is the last in the *ROSAN* series and takes the *ROSAN_{vm}* one step farther. The (P) refers to profiling, where the IRI is analyzed using FHWA's PRORUT II software.

The *ROSAN* series are available for loan to State Highway Agencies, researchers, pavement management personnel, and other interested in measuring and evaluating the macrotexture depth of pavement surfaces.

KJ Law is another manufacturer of automated pavement distress collection equipment. One model manufactured by KJ Law is the *KJ Law T6400*, a lightweight profilometer designed primarily for new or overlay pavement smoothness control. The system can be used to profile new road surfaces within hours after paving, allowing necessary potential corrective action to be taken before the surface is fully hardened.

The basic system consists of a precision accelerometer, an infrared non-contact height sensor with a large footprint, a graphic display, an IBM-compatible computer, and a parallel graphics printer. Inputs from the accelerometer and sensor are fed to the system's onboard computer, which calculates and stores true profile and a roughness index. The system operates at speeds between 5 to 15 mph.

Another model is the *KJ Law T6500*, a profilometer system, which measures and records pavement profile in each wheel path and rut depth. The basic system features two precision accelerometers and three infrared sensors.

The system's onboard computer can calculate one real-time, profile-based road roughness index and one off-line index. The program for rut depth computes and stores average rut depth every 100 feet from data taken every three feet, or at other selected intervals.

The system components are: three or more infrared sensors; an accelerometer for each wheel path; a VGA display; a computer with an industrial hardened 486 processor; and, a parallel graphics printer. Selected options will provide transverse profiles with rut depth measurements, geometrics, right-of-way videologging, pavement surface videologging, and a geographic positioning system.

A final model is the *KJ Law T6600*, a non-contact profilometer with an inertial system that measures and records pavement profile in each wheel path. The basic system consists of two precision accelerometers and three infrared sensors, which, when the inputs are fed into the system's onboard computer, produces pavement profiles, rut depths, and roughness indexes.

PAVEMENT CONDITION SURVEYS

The system's onboard computer can calculate one real-time, profile-based road roughness index and one optional index. The program for rut depth computes and stores average rut depth every 100 feet from data taken every three feet, or at other selected intervals.

The system components are three or more infrared sensors, an accelerometer for each wheel path, a VGA display, a computer with an industrial hardened Pentium processor, and a parallel graphics printer. Selected options will provide transverse profiles with rut depth measurements, geometrics, right-of-way videologging, pavement surface videologging, and a geographic positioning system.

The *DYNATEST 5051 RSP* test system is a road surface profiler. It consists of a mechanical/electrical transducer beam mounted on a minivan or full size van. The test system is able to measure, display, store, and calculate longitudinal road profile and roughness data in both wheel paths, including rut data, plus vehicle position and speed. The system is able to operate at speeds up to 50 mph.

The transducer beam consists of three laser displacement sensors and two accelerometers. To measure rutting, five lasers are required. A maximum of eleven lasers can be mounted on the beam to allow for the measurement of transverse profile. Each laser has the capacity to measure vertical displacement to a resolution of 0.001 inches or better.

An electronic, microprocessor-based signal conditioning and processing system allows for the interpretation of the laser sensors, accelerometers, and distance/speed encoder. It is based on the same principle as the South Dakota profilometer and computes the longitudinal profiles of both wheel paths in real time.

Procedures and process to fully automate the reduction of data from video-captured images is underway in both the public and private sectors. Several university research centers are examining the process in detail. NCHRP Project 1-27 "Video Image Processing for Evaluating Pavement Surface Distress" is nearing completion. The project objective is to develop, evaluate, and deliver a set of algorithms for processing video images to identify, quantify, and classify pavement distress at highway speeds, noting 1/16" cracks and other pavement distress types and patterns.

MHM Associates, IMS, Pavedex, PaveTech, Roadman-PCES, Inc., and VideoComp are developing processes to fully automate distress data quantification from video-obtained images. Both the hardware data collection equipment and the data reduction and analysis software processes vary considerably. Each vendor/manufacturer is developing a system to meet specific needs of their potential primary users. PCES-Roadman uses a high-intensity illumination system. VideoComp uses a partially contained illumination system. The others operate in daylight, and require more sophisticated software analysis to remove shadows of passing vehicles, clouds, overhead structures, and vegetation and the effects of the changing angles of the sun throughout the day and during the year.

PAVEMENT CONDITION SURVEYS

Complexity ranges from reasonably simple (other than software analysis, which is extremely complex regardless of the system) to extremely complex. The VideoComp design was based on the Idaho DOT stipulation that “off-the-shelf” components be used for the system, including the video cameras, recorders, distance measuring instrument and the illumination. PCES-Roadman, on the other hand employs sophisticated technology with line cameras to provide “real-time” processing of pavement images. VideoComp uses 3 cameras plus a fourth camera with a wide-angled lens to record a full-width pavement section (Figure 5.15).

Figure 5.15 VideoComp Camera Arrangement and Pavement Coverage

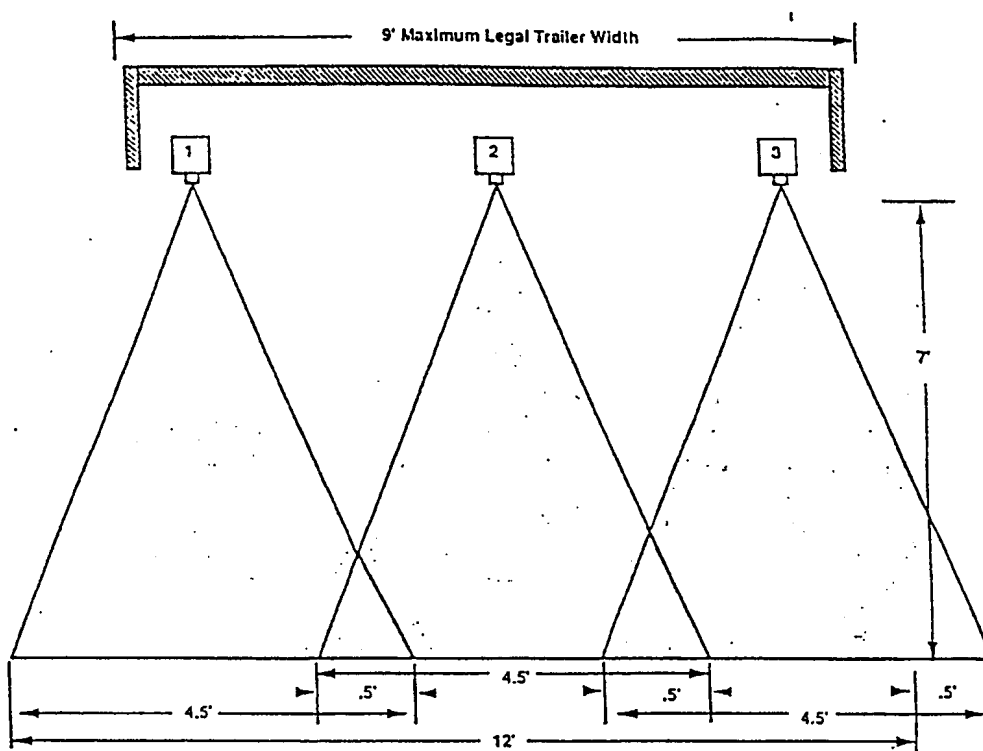

Roadman-PCES uses 2-4 cameras depending on the specified resolution. Two different mounting heights allow analysis of varying partial-width pavement sections. Pavedex and PaveTech use 5 cameras; 2 each on the front and rear of the vehicle aimed downward at the pavement surface, and a front, horizontally-mounted camera to provide a right-of-way perspective.

PAVEMENT CONDITION SURVEYS

It is very important to note that enhancements to all of these systems continue unabated. Communication with state highway agency users and the vendor/manufacturers is highly encouraged before using any distress data collection device. FHWA encourages all state highway agencies to automate the distress data collection process; using an automated system of their own choice based on the pavement distress prevalent on their system, and their budget. Most vendors will provide reasonably priced demonstrations if requested depending on geographic proximity to the state. Table 5.9 summarizes past, present, and projected future use of pavement distress, data collection equipment.

Table 5.9 Distress Equipment Trends

DEVICE OR PROCESS	NO. MID '80s	NO. 1990	NO. MID '90s
Visual Survey	23	37	15-25
Techwest or Photolog	7	1	0
ARAN or other video	0	5	15-25
Visual + Still Photo	3	3	2-5
Film	0	0	0-5?
Video + Image Processing	0	0	0-40?

DISTRESS EQUIPMENT REFERENCES: In June 1990, the Iowa DOT, FHWA and the Iowa State University sponsored the *Automated Pavement Distress Data Collection Equipment Seminar* in Ames, Iowa. Iowa State hosted the conference and produced an excellent proceedings documenting the presentations at the conference, listing equipment exhibitors and demonstrators, field survey results, and a list of some of the most commonly asked questions about pavement distress and pavement condition data collection equipment.

The technology in the area of pavement distress data collection and analysis is changing at a phenomenal rate. Image processing and pattern recognition systems will soon reliably, if not cost-effectively locate and quantify pavement distress from film or most likely, video images.

EQUIPMENT EVALUATIONS: A number of States have completed good evaluations of automated equipment during the past several years. Recent evaluations were performed by Washington, Pennsylvania, Iowa, and North Carolina. All had similar approaches to their evaluation i.e. they selected sections, invited (or paid) automated equipment vendors to perform the surveys, and then compared the results with manual surveys. In early 1997, both Pennsylvania and Washington completed studies to evaluate the equipment. Initially, the types of distresses that would be used to make decisions were defined. In the process, Pennsylvania developed an automated distress manual that closely followed the SHRP manual (9).

PAVEMENT CONDITION SURVEYS

Control sites were selected for the surveys, and the results of all the vendors were compared with manual surveys. The manual surveys were performed in great detail by experienced inspectors.

The results were mixed; in some cases, the variability in the automated equipment was greater than that for the manual distresses, while for others, they were similar. No overriding trends were found from all the states. In fact, the conclusions reached sometimes contradicted another state's.

However, it was clear from the studies that agencies need to carefully examine the distress data needs, and to prioritize them accordingly. Some equipment do not perform well with hairline cracks, or if moisture is present. Others only cover pavement that is the width of the vehicle, and so may miss distresses along the edge of the pavement or between lanes. None can measure raveling. The importance of setting up an appropriate location referencing system prior to the surveys is also critical, as Louisiana discovered.

Table 5.10 summarizes the various automated evaluation equipment discussed.

Table 5.10 Automated Crack/Distress Evaluation Equipment

Equipment	Data Output	Minimum. Crack Width Identified	Line Camera	Laser	Film-Based	Photometrics	Video System
Pasco Road Survey System	Continuous film: digitized in office	1/16"			√		
Pathway Services, Inc.	Video record						√
ARAN	Video record	1/16"					√
AREV		1/16"					√
ARIA System (MHM Assoc.)	Video imaging ¹	1/8"					√
PAS-1 (Pavedex, Inc.)	Video imaging ¹	1/16"					√
VIV (PaveTech, Inc.)		1/16"					√
VideoComp	Crack map	1/10"					√
Roadman PDI-1 (PCES, Inc.)	Continuous line video log	1/20"	√				
ITX Stanley Road Tester 3000	Video record	1/16"					√
Laser RST (IMS)	Crack characteristics – ASCII file	1/16"		√			
GIE System	Crack characteristics/ photometrics	1/8"		√		√	

¹Video Imaging – Video Record to be digitized in office

There are several advantages to these vehicles. Generally, they have capabilities to collect additional information such as signs, and to obtain a photolog of the highway.

PAVEMENT CONDITION SURVEYS

Most are equipped with computers to collect the data, although none can offer real-time processing as yet.

RUT DEPTH: Rut depth measurement at highway speeds is now as routine as profile measurement and roughness data collection. Several devices have been developed to measure rut depth such as the South Dakota Road Profiler, the Automatic Road Analyzer (ARAN), the Laser Road Surface Tester (RST), Pathway, IMS, PaveTech, and the PASCO Road Survey System. The first six use the inertial reference principle previously described. PASCO uses its own patented process.

The Road Profiler estimates rut depth using the ultrasonic transducer in the left wheelpath (which also is used in the profile measurements). Two other transducers mounted in the center of the vehicle and the right wheel path provide three data points for rut depth estimation. Rut depth is computed as shown in Figure 5.16 where h_1 , h_2 , and h_3 are the respective distances between the roadway surface and the left, center and right sensors. This actually represents the height of the hump between the wheelpaths. The three sensor system was selected to eliminate overwidth extensions which are required to collect a full transverse profile. Rut depth data is collected every two feet, and averaged and recorded every ten feet. A few states have purchased 5-sensor units to better estimate rut depth.

In recent years, more and more equipment vendors have developed techniques to measure rut depth that meet the proposed AASHTO protocols. The field is constantly and rapidly changing, with new equipment and technology being developed. It is beyond the scope of this workbook to provide a comprehensive survey of all equipment. Agencies are advised to contact the FHWA for updated lists of vendors.

Figure 5.16: Rut Depth Estimation with the South Dakota Road Profiler

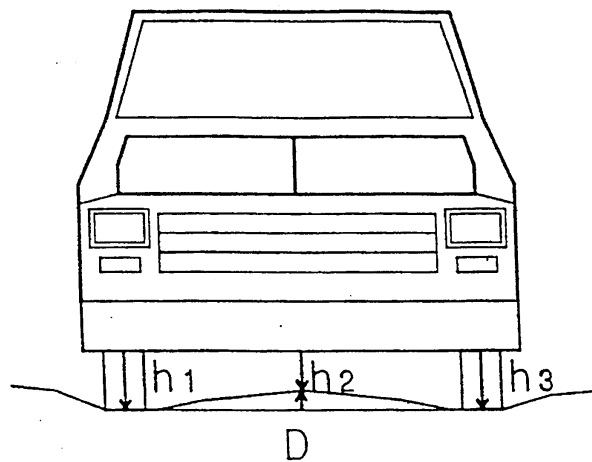

$$D = (h_1 - 2h_2 + h_3) / 2$$

The Laser RST uses eleven 32 kHz lasers in place of the ultrasonic sensors to measure the transverse profile using the inertial reference principle. The projected laser beam is reflected at an angle and received by a photodiode array. Elevation differences are

PAVEMENT CONDITION SURVEYS

computed using the principle of triangulation. Rut depth is measured continuously and averaged every 15 ft. The accuracy of the device is about 0.002” to 0.02” depending on the pavement texture.

Table 5.11 provides a comparative summary of equipment operating characteristics, accuracy, and number of agencies using each device. The ultrasonic sensors used on the South Dakota Road Profiler, KJ Law 8300A, and ARAN considerably reduce the device initial fabrication and operating costs compared to the optical profilometer or the laser devices. Acoustic sensors are not as accurate as the optical sensors, and short out when exposed to water. Their cost however, is much less than 1% of the optical sensors. Accuracy is suitable for network level surveys, and most project level survey needs. Table 5.12 summarizes the automated rut measurement equipment discussed.

Table 5.11 Acoustic and Optical Technologies

CRITERIA	ACOUSTIC SYSTEMS	OPTICAL & LASER SYSTEMS
No. of State Users	33	7
Measurement Principle	Speed of Sound through Air	Triangulation
Accuracy	0.04” – 0.08”	0.002” – 0.02”
Factors that affect Accuracy	Temperature, wind, texture, moisture	Wind, texture, & ambient light
Repeatability	Good	Good
Reliability	Good if kept dry	Good
Cost of 1 Replacement Sensor	\$20	\$10,000 - \$15,000
Operating Cost - \$ per lane mile	\$2-\$6 (owner agency) \$15-\$25 (vendor)	\$ varies by vendor and agency
Cost of Data Collection System	< \$50,000	> \$250,000

PAVEMENT CONDITION SURVEYS

Table 5.12 Automated Rut Measurement Equipment

<u>LASER (Infrared Sensor)</u> Vendor	Device	Operating Speed (km/hr)	Width Measured (mm)	Sensor Spacing (mm)	Transducer Frequency (Hz)
Dynatest	RSP 5051	Up to 100	3353	838	0 to 300
Pasco	RST	8 to 87	3200	N/A	N/A
KJ Law	T6600	16 to 112	N/A	N/A	N/A
KJ Law	T6500	32 to 112	N/A	N/A	N/A
Infrastructure Management Services (IMS)	Laser RST	8 to 89	3200	291	N/A
GIE Technologies	BIRIS	Up to 80	3658	900	60
<u>ACOUSTIC (Ultrasonic Sensor)</u> Vendor	Device	Operating Speed (km/hr)	Width Measured (mm)	Sensor Spacing (mm)	Transducer Frequency (Hz)
ITX Stanley	RT3000	0 to 100	N/A	N/A	N/A
South Dakota DOT	Road Profiler	8 to 97	N/A	N/A	N/A
PaveTech, Inc.	PaveTech	0 to 97	3658	N/A	125
Roadman-PCES, Inc.	PDI-1	0 to 97	1219	N/A	125
Highway Product International	ARAN	32 to 105	3658	102 - 305	N/A
Pasco	Roadrecon	0 to 97	4572	N/A	125

5.7 Structural Capacity

The function of the pavement structure is to effectively carry traffic and transfer wheel loads to the roadbed soils. Structural testing is the evaluation of the load carrying capacity of the existing pavement subsoils.

Structural data is not routinely collected for pavement monitoring by most agencies. Surface deflection data is mainly used for selecting and designing specific rehabilitation strategies for pavement sections under consideration. Exact location and frequency of structural testing within specified road sections should be carefully determined prior to seeking testing services. The tests should be limited to locations where distress and roughness surveys indicate structural problems and areas where overlays are anticipated. The results of these tests reflect the degree of structural adequacy that exists in the pavement structure.

Although expensive, structural testing can considerably reduce maintenance and rehabilitation costs. Many agencies use minimum or standard thickness for overlays. Thus, if a 50 mm (2-inch) overlay is the standard design and structural testing indicates that a 40 mm (1.5 inch) overlay will provide adequate strength, a saving of approximately 20 percent is realized. Structural testing can also determine the need for varying overlay thickness within a single project, thereby realizing considerable

PAVEMENT CONDITION SURVEYS

savings. For even a small project, reduced material costs easily justify the cost of structural testing.

On the other hand, an inadequate standard design can be even more costly. Nothing undermines support of a highway agency more quickly than a pavement which fails soon after construction.

The same considerations apply to aggregate surfaces. The cost of maintaining aggregate surfaces in rural areas can be a significant portion of total maintenance funds. Proper design results in one-time construction and eliminates the costly addition of aggregate at regular intervals.

Structural evaluation includes both destructive and nondestructive testing. Destructive testing involves coring and removing surface, base, and subsoil samples for laboratory testing to determine the load carrying capacity of the roadway. Another destructive procedure involves the excavation of pits for tests such as on-site plate bearing or field CBR (California Bearing Ratio). Samples of pavement layers and supporting soils are retrieved and tested in the laboratory to determine layer properties. The strength of the materials and types of damage present in each layer, are used to determine the load carrying capacity, the damaged layers, and the cause of structural failure. This information can then be used in a design and analysis procedure to determine whether the pavement is structurally adequate for current and projected traffic loadings (1,3,15).

Non-destructive testing (NDT) can also be used to evaluate the structural adequacy and load-carrying capacity of an existing pavement. NDT provides measurements of the overall pavement response to an external force or load without disturbing or destroying the pavement components (16). NDT has many advantages over the destructive testing methods including:

- § It provides in-situ properties of the pavement conditions
- § It does not damage the pavement
- § It minimizes laboratory tests
- § It is fast

The application of loads on a pavement surface includes strains (ϵ) in the underlying layers causing stresses in all layers. The summation of all vertical strains in the pavement structure and in the underlying sub-grade represents the surface deflection (δ) of the pavement. The deflection value is considered an excellent indicator of pavement strength; in other words, once deflection exceeds a certain limit, the pavement is certain to show some kind of structural weakness. Thus, a weaker pavement will deflect much more than a stronger pavement at a given load.

A number of non-destructive testing devices have been developed in recent years and are being used in the pavement structural evaluation analysis. All of these NDT devices provide some measure of surface deflection of in-service pavements in response to an external load.

PAVEMENT CONDITION SURVEYS

The non-destructive testing devices which are available in the United States to evaluate the in-situ properties of pavements are (16):

1. Benkelman Beam,
2. Dynaflect,
3. Road Rater, and
4. Falling Weight Deflectometer (FWD).
5. Rolling Deflectometer
6. Ground Penetrating Radar (GPR)

The first five devices operate by measuring the pavement response to an imposed force. The response is generally in terms of surface deflections at one or more points on the pavement. Major differences between these devices include the load levels, the way the load is applied to the pavement, and the number of points at which deflections are measured. A device that applies a static or slowly moving load is the Benkelman beam. The common devices that apply a vibratory steady state load to the pavement surface are the Dynaflect and the Road Rater. The device that uses an impulse loading is the Falling Weight Deflectometers (FWD). The rolling deflectometer is still under development in the United States.

BENKELMAN BEAM: This device is generally used to measure the rebound deflection of the pavement surface under a static or slowly moving single axle, double wheel load. An 8-foot-long (2.4 m) probe is placed between the dual tires [11.00 x 22.5, 12-ply and 70 psi pressure] of a truck which carries an 18,000 pounds (8,200 kg) single axle load. As the pavement is depressed, the beam pivots around a point of rotation on the reference beam which rests on the pavement behind the area of influence, so that the back extension of the beam depresses an Ames dial which records maximum deflection to within 0.001 inch (0.025 mm). While this device is limited to measurements of total deflection of a vehicle operating at creep speed, it has the very important advantages of simplicity, versatility, and rapidity of measurements (3,16).

DYNAFLECT: This device is an electro-mechanical device consisting of a dynamic force generator based on counter rotating fly wheels, and of five velocity transducers for sensing deflection mounted on a trailer. This device places a 1,000 pound (454 kg) peak to peak vibratory load on the pavement surface through two rubber covered steel wheels (3,16). The deflections are measured between the two loading wheels with velocity transducers and generally at 12 inch (0.3m) intervals from that point.

ROAD RATER: The Road Rater is also a steady state vibratory device which is trailer mounted and can be towed by a vehicle capable of pulling the trailer weight. Older models were mounted on the front of a vehicle. The maximum rated static loads are 2400 lbs., 3800 lbs., and 5800 lbs. for the models 400 B, 2000, and 2008 respectively. The load is applied to the pavement surface through a steel loading plate. The standard loading plates are 4 x 7 (102 x 178 mm) steel pads with a 5.5 inch (14 mm) center gap

PAVEMENT CONDITION SURVEYS

for model 400 B and a 12 inch (300 mm) diameter circular plate for the model 2000 and 2008. The dynamic force generator uses a lead-filled steel mass which is accelerated up and down by a servo-controlled hydraulic actuator. Both the amplitude and frequency can be changed by the operator. This allows different dynamic peak-to-peak rated loadings of 500 to 3000 lbs. for the model 400 B, 1000 to 5500 lbs. for the model 2000, and 1200 to 8000 lbs. for the model 2008. The force is measured with a strain gauge-type force transducer in most models. The loading frequency can be varied continuously from 5 to 70 cycles per second at 0.1 cycle per second increments with the normal working range in the 10 to 60 cycles per second range. The deflection is measured using at least four velocity transducers located in the center of the loaded area and general at 12 inch (0.3) intervals from that point (3,16).

FALLING WEIGHT DEFLECTOMETER (FWD): The Falling Weight Deflectometer is an impulse deflection device that lifts a weight to a given height on a guide system and then drops it. The falling weight strikes a specially designed plate, transmitting the impulse force to the pavement to produce a half-sine wave load pulse that approximates that of an actual wheel load. The magnitude of the load can be varied from 1,500 to 24,000 pounds (680 to 10,886 kg) on devices commonly used on roads and streets by changing drop height and the amount of weight. The load is transmitted to a 11.8 inch (300 mm) diameter load plate, and a strain type transducer measures the magnitude of the load. Deflections are measured using up to seven velocity transducers or linear variable distance transducers that are mounted on a bar and automatically lowered to the pavement surface with the loading plate. One transducer is placed in the center of the loading plate with the others placed at intervals up to 7.4 feet (2.25 m) from the first. It is a trailer mounted system (3,16).

The two primary NDT methods are vibratory and falling weight. Although both devices produce useful analyses of low-volume pavement structures, the falling weight deflectometer more closely approximates a heavy moving wheel load. Falling weight deflectometers induce a heavy enough load to yield meaningful results in rigid pavements. Nondestructive testing analysis requires knowledge of the existing pavement structure in terms of layer types and thickness. Coring of pavements may be necessary to support the analysis of NDT data. An NDT analysis will typically result in an evaluation of remaining service life of a pavement in terms of 18-kip equivalent single axle loads (ESALs), and an overlay thickness design.

ROLLING DEFLECTOMETER: The FHWA initiated a Small Business Innovative Research (SBIR) contract with Applied Research Associates (ARA), Inc. in 1996 to develop a rolling wheel deflectometer (RWD) for structural assessment of pavements. Phase I of the SBIR has been completed and Phase II has been initiated. Phase I research identified magnitudes of deflections (maximum values and basin offset values). The objective of the Phase II research is to develop a prototype RWD that is suitable for network level analysis in PMS applications. The RWD will collect data at highway speeds of 50 mph operating within traffic streams. A prototype RWD has also been developed independently by Quest Integrated Inc. and Dynatest. The primary data collected with an RWD will be deflection magnitudes and the shape and size of deflection basins.

PAVEMENT CONDITION SURVEYS

This presents a concern as to the best location to collect deflection data. The basin trailing the wheel is the longest, and that transverse is the shortest, with that ahead of the wheel being slightly less than that behind. The leading side represents the loading side and the trailing side represents the unloading response. Most of the historical data primarily measured the trailing portion of the basin due to convenience in measurement. However, for RWD applications, the leading portion of the basin is more convenient because comparisons are made to the undeflected pavement ahead of the load wheel. Additionally, the leading part of the basin may be less influenced by hysteresis effects. Both RWDs will collect deflection data, wheel load, pavement temperature, and travel speed (nominally 50 mph). In their FHWA Study ASA has proposed that the RWD data be processed in real-time to produce the pavement structural index. The data to be stored would only be the maximum deflection, structural index, pavement temperature, station numbers, data and time of the day. Although measurements are to be made continuously at 1-foot increments, the stored data will be for increments of 200 feet up to 1,000 feet, as determined by the operator. Using these increments will avoid excessive data storage requirements; all other data will be purged by the system and overwritten with new data.

Potential RWD Input into a PMS

In ARA's Phase I Study, they indicated concern for the large amount of data that could be created by a RWD. Potentially the RWD could produce a set of deflection measurements for every meter of highway. They proposed to use the deflection and load data to determine the effective structural number using the Burmeister's two-layer solution to determine the effective modulus for all pavement layers. ASA proposed using the same procedure that is used for the deflection based overlay design procedure developed in the 1993 AASHTO Guide for the Design of Pavement Structures to estimate the remaining service life. (28) The remaining structural service life would be determined by comparing the required design structural number to the existing effective structural number. The resulting remaining service life would be given in terms of a Structural Index which would be the Log of the remaining design Equivalent Single Axle Loads determined from the AASHTO design formula.

A somewhat similar approach was used in a special study to determine the project scopes in New Jersey's PMS. (29) In the New Jersey Study the authors also used the AASHTO deflection based overlay design procedure to determine the Effective Structural Number, but then compared it to the Required SN for a normal design procedure to determine the overlay thickness required for each section of pavement tested. Here they used standard FWD testing at a test spacing of about 10 tests per kilometer of highway.

Cost Comparison

The New Jersey Study provides a good basis for a cost comparison of the potential advantage of using a RWD to collect and process structural response for a PMS. Currently it cost about \$1,000 per day to run a standard FWD. With a reasonably productive measuring procedure, the FWD could perform 10 tests per kilometer over a

PAVEMENT CONDITION SURVEYS

distance of 15 to 20 kilometers per day. Since the FWD requires stopping on the travel pavement for every test, a traffic control crew is also required. Thus the total cost of FWD testing is about \$2,500 per day. If the production rate is about 20 kilometer per day the total cost of FWD testing is over \$100 per kilometer. Using a RWD, the production rate would be more in the order of 300 kilometers per day. Since RWD are still in the prototype development stage it is difficult to estimate what the actual operating cost will be. If they are say five times the current rate for FWDs which would be about \$5,000 per day, the much higher production rate of the RWD would bring down the structural survey cost to less than \$20 per kilometer.

5.8 Roughness

Pavement roughness measurements indicate whether irregularities in the roadway surface which adversely affect the ride of a passenger in a vehicle are present. Roughness is not only an important distress type itself but is also an indicator of other distress and can be used to prioritize visual distress surveys. Roughness evaluation measures the rideability of the pavement.

Pavement roughness is important for many reasons. Two of the most important are:

1. Public Perception – Roughness is the primary criteria by which the public judges the ability of a highway agency to maintain not only its pavements, but its entire highway network.
2. Pavement Performance – Roughness leads to more rapid deterioration of pavement structures. Some amplitude-wavelength combinations can cause dynamic forces of 50% - 100% in excess of static weights.

SERVICEABILITY CONCEPT: Until a measure of pavement serviceability was developed in conjunction with the AASHO Road Test, little attention was paid to the concept of highway performance or condition measured over time. A pavement was either satisfactory or unsatisfactory. The idea of “relative” performance was not well developed. Most pavement design concepts did not consider the level of performance desired, and design engineers had varied definitions of performance.

Results of the AASHO Road Test provided a badly needed method of pavement performance evaluation known as the “*serviceability performance concept*.” The evaluation of serviceability and performance depends on the interaction of three components: the pavement user, the vehicle, and the pavement itself. The serviceability scoring system measures the subjective reaction of a group of roadway users. The serviceability concept is based upon the following assumptions:

- § Highways are for the comfort and convenience of the traveling public.
- § Users’ opinions as to how they are being served by highways is largely subjective.
- § Characteristics of various pavements can be measured objectively and then related to the users’ subjective evaluation.

PAVEMENT CONDITION SURVEYS

- § Serviceability can be measured by the average evaluation of all highway users. Differences of opinions preclude the use of a single evaluation when rating serviceability. The average evaluation of all users, however, is a good measure of serviceability.
- § Performance is assumed to be an appraisal of the serviceability history of a pavement. The performance of a pavement can be described as serviceability observed over time.

The Serviceability Index was developed for the AASHO Road Test based on the above assumptions. The index is a 0 to 5 rating which can be determined by a panel rating, (using the average of all panel members' subjective evaluations), or by a mechanical roughness measuring device that correlates measured roughness to an average panel rating. Values based on panel ratings are known as Present Serviceability Ratings (PSR) and correlated mechanical measurements are known as Present Serviceability Indexes (PSI). A PSI is simply a mechanical estimate of the user's subjective evaluation of ride quality.

OTHER ROUGHNESS STATISTICS: Since the AASHO Road Test, many other statistics have been developed to quantify roughness levels on road surfaces. Many of these measures are summary statistics derived from precise measurements of road profile. Once a roughness meter is calibrated to one of these profile-based statistics, then the direct output of a roughness meter can be converted to the standardized roughness statistic. The most widely accepted roughness statistic is called the International Roughness Index (IRI). Other similar statistics include the Quarter Car Index (QI) and the standard Mays Meter number (MO). All of these statistics are similar in derivation in that they are initially obtained by a mathematical manipulation of the surface profile. Because of this, they are a more objective measure of roughness than the serviceability index and present serviceability ratings which are basically subjective.

Sayers (17) has compiled a thorough summary and discussion on the development of the IRI. The IRI evolved over many years, in three stages:

1. Quarter-car simulation on high-speed profilers. Routine analysis of road profiles began shortly after the General Motors (GM) profilometer was developed in the late 1960s. Like high-speed profilers today, it could measure true profile over a range of wavelengths affecting vehicle vibrations. One of the first research applications for this type of system combined measured road profiles with a quarter-car computer model that replicated the Bureau of Public Roads (BPR) Roughometer, a one-wheeled trailer with a road meter. GM licensed K.J. Law, Inc. to market the device commercially and continue its development. A commercial version was soon available that included a quarter-car analysis to summarize roughness of the measured profiles. Users of early K.J. Law profilometers could choose between two quarter-car data sets: one for the BPR Roughometer and one for a 1968 Chevrolet Impala.
2. NCHRP research and the Golden Car. In the late 1970s, NCHRP sponsored a study of response-type road roughness measuring systems such as the BPR Roughometer and vehicles equipped with Mays ride meters. The results were published in *NCHRP Report 228 (18)*. An objective of the study was to develop calibration methods for the response-type systems. The researchers, Gillespie and Sayers, concluded that the only valid methods was *calibration by*

correlation against a defined roughness index. The best correlation was obtained by using a vehicle simulation with a set of parameter values that is often called the *Golden Car*. (The name is based on the concept of a golden reference instrument kept in a vault and used to calibrate other instruments).

The NCHRP study provided a standard quarter-car model, and users of K.J. Law profilometers soon had access to an analysis called *Mays simulation*, which used the Golden Car data set.

3. The World Bank development of IRI. In 1982, the World Bank initiated a correlation experiment in Brazil called the International Road Roughness Experiment (IRRE) to establish correlation and a calibration standard for roughness measurements. In processing the data, it became clear that nearly all roughness-measuring instruments in use throughout the world were capable of producing measures on the same scale, if that same scale had been selected suitably. Accordingly, an objective was added to the research program: develop the IRI.

The main criteria in designing the IRI were that it be relevant, transportable, and stable with time. To ensure transportability, it had to be measurable with a wide range of equipment, including response-type systems. To be stable with time, it had to be defined as a mathematical transform of a measured profile. The Golden Car simulation from the NCHRP project was one of the candidate references considered, under the condition that a standard simulation speed would be needed to use it for the IRI. The quarter-car was selected for the IRI because it could be used with all profiling methods that were in use at that time. The consensus of the researchers and participants is that the standard speed should be 80 km/hr (49.7 mph) because at that simulated speed, the IRI is sensitive to the sample profile wavelengths that cause vehicle vibrations in normal highway use.

The World Bank (19) defined two classes of profiling methods that were later adopted by the FHWA for the HPMS data base. Profilometers are considered Class 2 if they produce IRI measures that are neither high nor low on the average. However, an individual measurement is expected to have random error. Some profilometers clearly are more accurate than others, so the concept of a Class 1 measurement was introduced to define a reference that can be used to determine the accuracy of other instruments. A Class 1 instrument must be so accurate that the random error is negligible: its IRI measure is “the truth.”

When the IRI was defined in the World Bank Technical Report, there were only about a half-dozen inertial profilometers in America. Since then profiling has become the primary means for measuring road roughness in the United States. More than half the states have purchased or built profiling systems. The federal government maintains a fleet of profilometers for calibration and research programs, and consulting companies maintain profiling systems to provide measures to states and local districts that do not have their own equipment. FHWA has encouraged profiler use and has sponsored several correlation experiments. Profiler users have organized into the Road Profiler

PAVEMENT CONDITION SURVEYS

User Group, which has established an annual correlation experiment for several years in which users are invited to measure profiles and IRI for test sites.

The profilers in use cover a wide variety of sensor types, cost, and analysis options. Limited by the speed of sound, systems with ultrasonic sensors can measure profile at intervals no closer than 300 mm (1 ft) at highway speeds. Other systems, with laser sensors, can measure at intervals going down to a few millimeters. Some systems perform minimal profile filtering. Others routinely smooth the data to avoid aliasing and remove long wavelengths to standardize plot appearances. Even with these differences, most profilers in use can obtain IRI measures that show reasonable agreement (within 5 percent).

However, recent correlation experiments show that no existing profiler can measure “true IRI” with the high accuracy one might expect of a Class 1 instrument (i.e., within 2 percent). Further research is needed to determine the reasons that consistent measures of roughness are not obtained. Two possible sources of discrepancy are user practice and changes in road profile due to temperature and environmental effects.

The following points fully define the IRI concept:

1. IRI is computed from a single longitudinal profile. The sample interval should be no larger than 300 mm for accurate calculations. The required resolution depends on the roughness level, with finer resolution being needed for smooth roads. A resolution of 0.5 mm is suitable for all conditions.
2. The profile is assumed to have a constant slope between sampled elevation points.
3. The profile is smoothed with a moving average whose base length is 250 mm.
4. The smoothed profile is filtered using a quarter-car simulation, with specific parameter values (Golden Car), at a simulated speed of 80 km/hr (49.7 mph).
5. The simulated suspension motion is linearly accumulated and divided by the length of the profile to yield IRI. Thus, IRI has units of slope, such as inches per mile or meters per kilometer.

ROUGHNESS MEASURING EQUIPMENT: Equipment for roughness survey data collection may be categorized in 4 primary categories:

1. Rod and Level Survey, and the Dipstick Profiler
2. Profilographs
3. Response Type Road Roughness Meters (RTRRMs), and
4. Profiling Devices

PAVEMENT CONDITION SURVEYS

Rod and Level: Surveying instruments can be used to determine the accurate profile of a road at any desired spacing. However, this requires normal rod and level measurements which are time consuming and require closing the road during the survey.

Dipstick Profiler: A first-step automation of the rod and level survey is by profile measurement with the Dipstick .

The Dipstick consists of an inclinometer in a case supported by two legs separated by 12 inches. Two digital displays are provided, one at each end of the instrument. Each display reads the elevation of the leg at its end relative to the elevation of the other leg. The operator then “walks” the Dipstick down a premarked pavement section by alternately pivoting the instrument about each leg. Ten to 15 readings per minute are recorded sequentially as the operator traverses the section. Software analysis provides a profile accurate to plus or minus 0.005 inch.

The most prevalent use of the device has been for manually profiling roughness calibration sections for the calibration of RTRRMs. Two versions of the device have been developed. Special care must also be taken to ensure that the Dipstick feet do not change location, destroying the reference elevation during the survey. The manufacturer has developed rubber boots to help maintain contact on certain aggregates in paved surfaces.

Profilographs: The most common device to monitor construction quality control on Portland cement concrete pavements is the profilograph. Profilographs have been available for many years and exist in a variety of forms, configurations, and brands. Due to their design and low-speed operation (walking speed), they are not suitable for condition surveys. Profilographs should never be used to calibrate other roughness data collection equipment.

Response Type Road Roughness Meters (RTRRMs): Road meters or RTRRMs collected the bulk of pavement roughness data from 1940 through the late 1980s. Two very serious limitations, however, have helped speed the movement away from the RTRRMs:

1. Profile Measurement – RTRRMs cannot measure pavement profile. They record the dynamic response of the mechanical system travelling over a pavement at a constant speed. The characteristics of the mechanical system and the travelling speed affect the data.
2. Calibration – In order to provide accurate, consistent, and repeatable data, the devices must be frequently calibrated through a range of operating speeds, against sections of known profile. The cost of this activity is high.

Due to the limitations and the development and nationwide use of low-cost profiling devices, the RTRRMs are not used much today - except to correlate existing roughness databases to the new profiling devices. In a few years, the RTRRMs will be used very little, if at all.

This equipment is easy to use, relatively inexpensive, and can be operated at speed close to normal traffic speed. Several types of devices are available, but the May’s Ride Meter will be presented for information.

PAVEMENT CONDITION SURVEYS

The May's Ride Meter (MRM) provides roughness measurements proportional to the vertical distance changes between the vehicle body and its rear axle as the vehicle travels over a pavement. The primary advantages of the MRM include initial cost, ease of operation, and the roughness record provided. However, the vehicle must travel at a constant speed for at least one-tenth mile (0.16 km) long sections, which is often difficult in city streets. In addition, the MRM must be calibrated frequently to ensure that reasonable accuracy in measurements is achieved (3).

Profiling Devices: Profiling devices provide accurate, scaled, and complete reproductions of the pavement profile within a certain range. They eliminate the time consuming, labor intensive calibration process necessary to collect reliable data with response type road roughness systems and can also be used to calibrate RTRRMs. Today, most agencies use the inertial reference systems for measuring pavement profile. The devices measure, compute, and store the profile through the creation of an inertial reference by using one or two accelerometers on the body of the vehicle to measure the body vertical motion in one or both wheelpaths. The relative displacement between the accelerometer and the pavement surface is measured with an acoustic, optical or laser sensor. A summary of the process is as follows:

1. *Accelerometer* – Measures the vertical displacement of the vehicle as a function of time.
2. *Distance Measuring Instrument* – Measures the horizontal distance of vehicle travel.
3. *Sensor* – Measures the vehicle's height above the roadway surface at equally spaced intervals of distance.
4. *On-board Computer System* – Synchronizes subtraction of the vehicle displacement and height measurements to compute the relative profile, stores the computed profile, and reconstructs a filtered profile from the stored profile. Figure 5.19 illustrates the process.

The states have moved rapidly from RTRRMs that collected pavement response data, to profiling devices that measure pavement profile. Most of these devices include software analysis packages that can calculate any of the previous roughness indices computed from the response data as well as pavement profiles, filtered at varying cutoff lengths. Profiling has greatly improved the analysis of pavement condition, and provides clues to engineering rehabilitation and maintenance strategies that were not possibly to develop from the RTRRM data. Several states already develop strategies using profile data or profile data in conjunction with distress data.

Figure 5.19 The Inertial Reference Principle

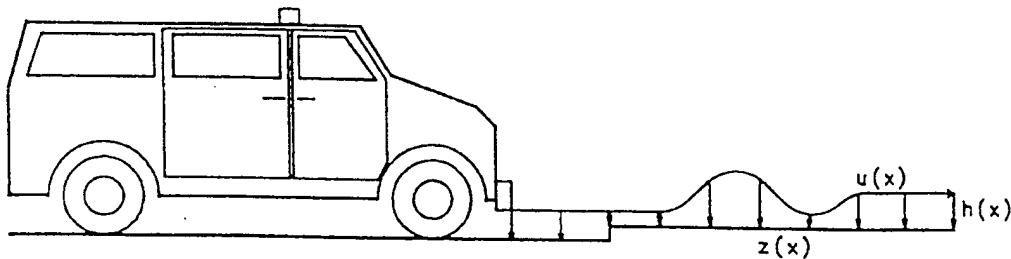

$h(x)$ - Vehicle Height above Pavement

$u(x)$ - Vehicle Position

$z(x)$ - Vertical Road Profile

$$\text{Pavement Profile} = z(x) = u(x) - h(x)$$

The K.J. Law 690 DNC profilometer uses the inertial reference principle to measure profiles in both wheelpaths. Relative displacement between the accelerometers and the pavement surface is measured with a highly accurate non-contact light beam measuring system. Differential pavement elevation is determined using the principle of triangulation. Profile computations are performed at six inch intervals in real time as the device traverses the pavement section. One inch data points are measured and averaged over a 12" interval and recorded as profile every six inches of travel. Vertical resolution is 0.01 inch. The operator may select wavelengths for filtering, which do not change during vehicle speed alteration. The device simulates the Mays, PCA roadmeter, and BPR Roughometer indices, and computes PSI values from a mathematical model using a comparison to a panel roughness rating.

Until a few years ago, sophisticated road profiling equipment was extremely expensive. This is not so today. In 1981, the South Dakota Department of Transportation (SDDOT) designed and constructed a low-cost Road Profiler. Between 1982 and 1986 SDDOT enhanced the Road Profiler's capabilities and added two additional sensors to estimate rut depth. The current Road Profiler collects pavement condition data at highway speeds, surveying about seven hundred miles of pavement during a forty-hour work week. The Road Profiler software allows data reporting in various forms-filtered profiles, roughness ratings, and power spectral density. The SDDOT has shared the Road Profiler technology and provided technical assistance to other State highway agencies (SHAs) interested in procuring a similar device. About 25-30 other SHAs have indicated an interest in the system. Twenty-four have now fabricated replicate units, either in-house or through an equipment vendor or plan to do so in the near future.

Interested States have formed a User's Group and participated in meetings during 1989 to 1990 to provide technical information about the device, share information about system enhancements, evaluate the capability of the units, and make future

technological innovations available to the users. One of the Road Profiler's advantages is its comparatively low initial and operating costs. A system may be assembled for about \$50,000, including the van. Operating costs have been very low, on the order of \$2.00 per lane mile in South Dakota. Pennsylvania has reported data collection costs of about \$5.00 to \$6.00 per lane mile. Roughness data can be reported in International Roughness Index units, satisfying FHWA 1989 Highway Performance Monitoring System requirements to report roughness data in this form. The wide-spread use of the Road Profiler will eventually lead to a much-improved assessment of the HPMS pavement roughness reporting requirements, and will ultimately revise them due to the rapid, nearly universal practice of collecting pavement profile, not response data.

Side by side tests comparing home-built and commercially manufactured units were conducted during the two User's Group meetings in Pierre, South Dakota in November 1989, and Cheyenne, Wyoming in September 1990. The test results were compared with manual profiles and comparisons were made between devices. The level of precision and repeatability of each device was also assessed in terms of comparability with manual profile, comparability among devices, level of precision, accuracy, and repeatability. Future User Group meetings have been planned. Continued enhancements to the Road Profiler hardware and software are anticipated. Some have already occurred. For example, several states have purchased an IBM-PC based system to correspond more directly with their own departments IBM-based computer databases.

5.9 Skid Resistance (Surface Friction)

Skid resistance measurements of highways, roads, and streets, are generally for safety analysis and on locations where accidents are suspected of being caused by deficiencies in surface skid resistance. Specialized equipment frequently used to measure surface friction can be categorized as portable field devices and trailer devices.

TRAILER DEVICES: Generally, these devices consist of a trailer towed, usually at 40 mph, over the dry pavement with water applied to the pavement ahead of the test tire. The most common trailers under this class of equipment used in the US includes the Locked-Wheel-Trailer and Yaw Mode. These devices are generally most applicable for skid measurements on straight sections of through roads. They are difficult to use on many city streets.

Locked Wheel Mode: A trailer is towed, normally at 40 mph. Water is applied in front of the test wheels, and the test wheels are locked. The force required to drag a tire that is prevented from rolling over the wet pavement is measured after the test wheel has been sliding on the pavement for a certain distance (i.e., after the temperature has been stabilized). A skid number (SN), where: $SN = 100 \times \text{Friction Factor}$ is calculated for that part of the pavement. Skid number is the standard procedure for evaluating the coefficient of friction between a tire and pavement. A standard bias-ply 7.5 x 14 tire (ASTM E534) is specified to eliminate tire type and design as variables in the measurement of skid resistance. The skid number calculated by this method is dependent on temperature, and because of the complex relationship between air, water, pavement, and tire, no satisfactory method has been developed for correcting the skid number for temperature (3).

PAVEMENT CONDITION SURVEYS

Yaw Mode: The test wheel (unbraked) is directed at an angle from the direction of motion and the sideways friction factor is measured. At some Yaw angle, the side force peaks. Since the critical Yaw angle is subject to many variables, there is controversy concerning which constant Yaw angle the wheels should be set at during testing. An angle should be used that is relatively insensitive to differences in surface characteristics and operating conditions (3).

The Mu-Meter, developed in England, is a fairly simple version of a Yaw mode device. The Mu-Meter is a three-wheeled towed trailer in which two friction-measuring wheels and a rear wheel are mounted on a triangular frame. The two smooth outer wheels are set at an angle of 7 ½ degrees from the line of travel. A rear, middle wheel measures the distance of travel and holds the trailer on a stable course. By use of a simple load cell and the recorder, distance and the coefficient of friction are recorded as friction is encountered on the pavement. The speed of the test wheel ranges from 40 mph to 100 mph. A water delivery system is available to distribute water in front of the two wheels that measure friction.

Automated procedures to measure pavement friction have been available since the 1940's. The locked wheel friction tester has been, and remains the work horse data collection unit.

Table 5.13 summarizes past, present, and projected future friction measuring equipment trends.

Table 5.13 Friction Equipment Trends

DEVICE	NO. MID '80s	NO. 1990	NO. MID '90s
Locked Wheel Tester	38	41	35-45
Mu-Meter	4	2	0-2
Spin-Up Tester	0	0	0-10?
Laser or Image Processing	0	0	0-20?

New methods to improve testing efficiency and reduce skid testing costs and device wear and tear are underway. Recent studies indicate that the spin-up tester may produce accurate results at lower costs. Like the locked wheel tester, the device is trailer mounted. Testing begins following the locking of the wheels and continues after the release of the brake until the wheels reach full angular velocity. The time interval between the moment the brake is released and the achievement of full angular velocity is indicative of the pavement surface friction.

Developmental efforts to correlate pavement surface texture to a locked wheel skid number are ongoing with both video systems and laser devices. The University of New South Wales (Australia) has developed the Yandell Mee Friction Tester which

PAVEMENT CONDITION SURVEYS

correlates skid resistance and texture depth to both sideways force and the locked wheel modes. The device uses a video camera, tracking device, and image enhancement to capture an enlarged video picture of the pavement surface. An on board computer collects the data. Software performs a statistical analysis of the texture, and produces output data on the friction factors. The vehicle must be stopped to conduct the 30-second test. Results are processed in real time to provide the skid numbers at various vehicle velocities.

The Laser RST and other equipment measures pavement macrotexture at highway speeds using 32 kHz lasers. The device cannot however, measure pavement microtexture, which also has some influence on skid resistance. Development of 64 kHz lasers for this purpose and for travelling deflection measurement is ongoing.

PORTABLE FIELD DEVICES: Several portable field devices have been developed to measure skid resistance. Some of these devices include the Keystone Tester and the California Skid Tester. These devices are most suitable for measuring friction on city roads and streets and can be useful in measuring skid resistance on the approaches to a stop sign or a traffic signal and in similar locations where accident frequencies are usually high.

The Keystone Tester: A hand carried device that employs a rubber shoe that slides along the pavement as the operator “walks” the tester. The frictional resistance experienced by the shoe is converted to hydraulic pressure and displayed on a gauge. Water must be applied to the pavement ahead of the tester when water accidents are considered (17).

The California Skid Tester: It operates on the principle of spinning a rubber-tire wheel while it is off the ground, lowering it to the pavement, and noting the distance it travels against the resistance of a spring before it stops. This device is attached to the rear of a suitable vehicle, which is stationary during a test. This tester is normally operated with glycerine instead of water as the pavement lubricant, because glycerine ensures a longer lasting, and more uniform film (20).

These Portable Testers are relatively inexpensive. They also permit friction to be measured in locations where a trailer tester cannot operate. However, they are generally considered less accurate than the trailer testing devices.

INTERPRETING FRICTION TESTING: Most agencies use a skid number to indicate the level of surface friction on a pavement surface. As this number decreases, the surface friction decreases. Low numbers should indicate greater potential for accidents, especially in wet weather.

5.10 Aggregate Surface Roads

Aggregate surfaces can be completely integrated into a surface management program. However, special considerations should be made for these roads.

The maintenance of unbound surfaces is an important concern usually to local governments in rural areas, although federal agencies such as the Bureau of Indian Affairs and the Forest Service also own and manage large unsurfaced road networks.

PAVEMENT CONDITION SURVEYS

Keeping these roads passable under adverse weather conditions requires a substantial portion of maintenance funds. Approximately half of the road mileage in the U.S. consists of unpaved surfaces. Although these roads carry small portions of the total traffic volume, they remain a vital aspect of the economy because they provide land access and service for agricultural needs.

The term “unpaved” is misleading. Most, if not all, unpaved roads consist of a stabilized surface. Whether existing materials are used or additional materials added, the resulting all-weather surface is actually an unbound pavement and must be treated as such..

Unbound surfaces are much more dynamic than bound pavements and their condition can deteriorate rapidly. However, routine maintenance procedures improve conditions just as rapidly. Maintenance must be performed more frequently than for paved or bound surfaces.

CONDITION ASSESSMENT OF AGGREGATE TESTING: The important condition factors in aggregate surfaces are: roughness or corrugation, dust generation, drainage, rutting, gravel loss and potholes. Each of these factors are discussed below:

- § Roughness – When evaluating roughness on aggregate surface different criteria must be used than for pavements. A higher level of roughness can be tolerated than on surfaced roads. The most important roughness distress is corrugation. Corrugation is caused by a loss of fines in the surface gravel due to dust generation or washing. Corrugation can be corrected by reblading or, when severe, by applying new gravel and reblading.
- § Dust Generation – Dust from unpaved roads can be a nuisance to property owners, a potential safety problem, and a cause of environmental damage. It results in a loss of fines in the surface gravel, as explained above. When evaluating dust generation, characteristics of adjacent property and slight distance requirements must be considered. Some locations tolerate more dust than others. Dust generation can be controlled by various methods of surface stabilization, such as liquid asphalt spray or liquid calcium chloride.
- § Drainage – The crown of an aggregate road is subject to change. The adequacy of the crown should be considered when evaluating the condition of unpaved surfaces. The uniformity of the crown cross-slope is very important. When unpaved surfaces are not properly bladed, a “secondary ditch” appears at the edge of the roadway. This secondary ditch intercepts drainage and channels it to the traveled way rather than allowing it to cross the shoulder and enter the constructed ditch. Proper blading techniques maintain a proper crown and prevent development of secondary ditches. Full width blading may be necessary to maintain shoulders and adequate ditches.
- § Rutting – Rutting in the wheel paths is common in unpaved surfaces. Rutting interrupts cross drainage and creates safety problems. As with roughness, criteria for evaluating rutting must take into account the nature of unpaved surfaces. There are two causes of rutting. It can be caused by repeated tire action on the cover gravel, resulting in the displacement of the gravel. More seriously, rutting can be a structural problem resulting in plastic deformation of the base material. Rutting is corrected by regrading, unless it is the result of structural problems in the base. An inadequate base must be corrected by reconstruction and good compaction.
- § Gravel loss – Unbound surfaces with gravel cover lose material over time due to the action of traffic. This is particularly true if the surface material has a low plasticity. Gravel loss is more severe on roads that have higher traffic volumes, heavier truck loadings, steep grades, and frequent turns and curves. Gravel loss is corrected by regrading and reblading. Excessive gravel loss might justify a stabilization treatment.

PAVEMENT CONDITION SURVEYS

§ Potholes – Potholes develop rapidly in unpaved surfaces as a result of poor drainage, traffic action, loss of cover gravel and weaknesses in the base. Deep and extensive potholes might require localized base reconstruction and recompaction. Less severe potholes can be corrected by reblading.

5.11 Drainage Surveys

Poor drainage causes poor pavement performance. Water allowed to pond on the pavement surface creates a hazard to motorists, saturates the subgrade soil, and causes deterioration of the pavement. Ditches which are allowed to silt in and collect debris provide poor drainage. Moisture then becomes trapped in the subgrade or base with pavement failure a likely result.

Pavement failure within the design life is caused by two main factors: load and moisture. Load capacity can be increased by an overlay. A moisture related distress indicates a drainage problem in the base or subgrade. If proper drainage of each pavement element is not provided during rehabilitation, the same moisture related distress will recur.

The survey team should be instructed to identify surface drainage problems. High shoulders can cause ponding of water on the pavement surface and erosion along the pavement edge. Debris can block storm sewer inlets and cause flooding of the roadway. Correction of these defects can then be scheduled.

Other signs of deficient surface drainage which may be detected during a visual survey are:

- § Standing water in ditchlines.
- § Concentrating weed growth indicating saturated soil in ditchline or at edge of pavement.
- § Evidence of water ponding on the shoulder.
- § Deteriorated joint or crack sealants.
- § Any evidence of pumping.

Additional drainage problems may not be so obvious. Subsurface drainage depends upon material properties of the subgrade soil. Pavement distress may be the only outward indication of a saturated subgrade soil or base. The recognition of the mechanisms causing such distress is necessary to choose the appropriate rehabilitation procedure. Tables 5.2 and 5.3 summarize the causes of distress in asphalt and concrete surfaces.

5.12 Deciding How Much Data to Collect

To support network-level analysis, sampling processes can be used to reduce data collection costs (1). Sampling is conducted by measuring information about a part of the whole that can be used to estimate something about the whole (21). Standard sampling techniques are used to avoid collecting “unrepresentative” data that could bias the estimates (21,22,23).

PAVEMENT CONDITION SURVEYS

Sampling can be conducted on a network or section basis. To estimate the condition of the network for planning purposes, only a sample of the system needs to be surveyed for each measure selected to be used, e.g., only a portion of the data collection or management section will need to be surveyed. However, if individual sections are to be identified as needing maintenance or rehabilitation in the PMS, then the condition of each section must be known, e.g., each section must be surveyed but only a portion of each section can be surveyed.

NETWORK SAMPLING: Studies conducted about the sampling of condition based on distress have generally been based on collecting information to predict a condition index. In two such studies, the pavement evaluation score (PES) used by the Texas Department of Transportation (TxDOT) were considered in addition to serviceability index based on roughness and surface curvature index based on Dynaflect measurements (24,25). The results were considered adequate to represent conditions on a state-wide basis and for district stratification of the statewide network.

All sampling studies indicate that a smaller percentage of the samples will need to be inspected when the total number in the whole increases. This generally leads to the conclusion that a greater percentage of arterial roads and streets will need to be inspected than for residential and local roads and streets. References 22 and 23 give detailed instructions on selecting sample sizes for different conditions. The TxDOT studies found that a sample size of 2 to 5 percent, depending on the size of the network being sampled, will be adequate to determine average condition (24). If the goal is to predict the distribution of condition so that the percent of the network below some selected score can be identified, then a sample size of 10 to 15% was needed (25). If the goal is to predict the cost to repair those sections of pavement below some selected value, a sample size of 30 to 35 percent is needed (25). This approach will support overall planning concepts. Many states survey the first 500 feet of a mile, which corresponds to approximately 10%.

SECTION SAMPLING: If a goal of the PMS is to identify those sections of pavement that are in a selected condition level that requires some specified treatment, the condition of each section must be defined. However, this does not mean that each section of pavement must be inspected every year or that 100 percent of the area of each section must be inspected.

If a windshield survey is used to inspect the pavements, then normally the entire management or data collection section is inspected each time. However, if a walking survey or an automated survey vehicle is used, the inspection costs can be reduced by inspecting only a portion of each management or data collection section. The management or data collection can be divided into sample units or inspection units of approximately equal size, and only a portion of those are inspected.

FREQUENCY OF SURVEYS: Not all sections need to be inspected every year, especially if the PMS has a method of projecting future condition. More important sections, such as those on the interstates, can be inspected every year while those sections with lower usage can be inspected every second or third year. Those in better condition and with lower rates of deterioration can be inspected less often than those deteriorating quickly.

PAVEMENT CONDITION SURVEYS

A condition projection method can be used to bring all section conditions to a common period for analysis.

5.13 Summary

Finally, two appendices have been included. Appendix 5A is a sample of the distress evaluation charts used in New Mexico for their manual survey. Appendix 5B is a reproduction of the draft AASHTO protocols for pavement condition data collection. They have been included as information for users of this workbook.

REFERENCES

1. Hicks, R.G., and J.P. Mahoney, "Collection and Use of Pavement Condition Data," NCHRP Synthesis 76, Transportation Research Board, Washington, DC, 1981.
2. Shahin, M.Y., and S.D. Kohn, "Development of a Pavement Condition Rating Procedure for Roads, Streets, and Parking Lots," Technical Report M-268, U.S. Army Construction Engineering Research Laboratory, Champaign, IL, 1979.
3. Epps, J.A., and C.L. Monismith, "Equipment for Obtaining Pavement Condition and Traffic Loading Data," NCHRP Synthesis 126, Transportation Research Board, Washington, DC, 1986.
4. Cable, J.K., and V.J. Marks, "Automated Pavement Distress Data Collection Equipment Seminar," FHWA-TS-90-053, Iowa DOT, Ames, IA, and Federal Highway Administration, Washington, DC, 1990.
5. Paterson, W.D.O., and T. Scullion, "Information Systems for Road Management: Draft Guidelines for System Design and Data Issues," Report INU77, Infrastructure and Urban Development Department, World Bank, Washington, DC, 1990.
6. APWA, "APWA PAVER Condition Index Field Manual – Asphalt," American Public Works Association, Chicago, IL, 1984.
7. APWA, "APWA PAVER Condition Index Field Manual – Concrete," American Public Works Association, Chicago, IL, 1984.
8. "Distress Identification Guide for Asphalt Surface Pavements," 2nd Ed., Metropolitan Transportation Commission, Oakland, CA, 1985.
9. SHRP, "Distress Identification Manual for Long-Term Pavement Performance Project," SHRP-P-338, Strategic Highway Research Program, National Research Council, Washington, DC, 1993.
10. Eaton, R.A., Gerard, S., & Cate, D.W. "Rating Unsurfaced Roads: A Field Manual for Measuring Maintenance Problems," U.S. Army Corps. Of Engineers, Cold Regions Research & Engineering Laboratory, Special Report 87-15, Sept. 1988.

PAVEMENT CONDITION SURVEYS

11. Hyman, W.A., et. al., "Improvements in Data Acquisition Technologies for Maintenance Management Systems," NCHRP Report 334, Transportation Research Board, Washington, DC, 1990.
12. NACE Action Guide, Volume III-1 "Road Surface Management, National Association of County Engineers, 1992.
13. "Road Surface Management System (RSMS)," New Hampshire Technology Transfer Center, University of New Hampshire, Durham, NH, 1992.
14. "Automated Pavement Condition Collection Equipment," Resource Paper by FHWA Pavement Division, in "Pavement Notebook for FHWA Engineers," FHWA-ED-90-016, Federal Highway Division, Washington, DC, 1990.
15. ERES Consultants, Inc., "Techniques for Pavement Rehabilitation," Participants Manual, National Highway Institute, Federal Highway Administration, Washington DC, 1987.
16. Smith, R.E., and R.L. Lytton, "Synthesis Study of Nondestructive Testing Devices for Use in Overlay Thickness Design Flexible Pavements," FHWA/RD-83/097, Federal Highway Administration, Washington, DC, 1984.
17. Sayns, M.W., "On the Calculation of International Roughness Index from Longitudinal Road Profile," TRR 1501, Transportation Research Board, Washington, DC, 1995.
18. Gillespie, T.D., Sayers, M.W., & Sepel, L. NCHRP Report 228: *Calibration of Response-Type Road Roughness Measuring System* TRB, National Research Council, Washington, DC, 1980.
19. Sayers, M.W., Gillespie, T.D., & Patterson, W. *Guidelines for the Conduct & Calibration of Road Roughness Measurements*. World Bank Technical Paper 46. World Bank, Washington, DC, 1986.
20. NCHRP, "Skid Resistance," NCHRP Synthesis 14, Transportation Research Board, Washington, DC, 1972.
21. Thompson, S.K, *Sampling*. A Wiley-Interscience Publication, John Wiley & Sons, Inc., New York, NY, 1992.
22. ASTM, "ASTM Standards on Precision and Bias for Various Applications," American Society for Testing and Materials, Philadelphia, PA, 1992.
23. Brush, G.G., "How to Choose the Proper Sample Size," Volume 12, the ASQC Basic References in Quality Control, Milwaukee, WI, 1988.
24. Mahoney, J.P., and R.L. Lytton, "Measurements of Pavement Performance Using Statistical Sampling Techniques," Research Report 207-2, Texas Transportation Institute, Texas A&M University, College Station, TX, 1978.
25. Templeton, C.J., and R.L. Lytton, "Estimating Pavement Condition and Rehabilitation Costs Using Statistical Sampling Techniques," Research Report

PAVEMENT CONDITION SURVEYS

- 239-5, Texas Transportation Institute, Texas A&M University, College Station, TX, 1984.
26. Shahin, M.Y., and J.A. Walther, "Pavement Maintenance Management for Roads and Streets Using the PAVER System," USACERL Technical Report M-90/05, US Army Corps of Engineers Construction Engineering Research Laboratory, Champaign, IL, 1990.
 27. Gramling, W.L. "*Current Practices for Determining Pavement Condition,*" NCHRP Synthesis 203. Transportation Research Board, 1994.
 28. "*AASHTO Guide for the Design of Pavement Structures 1993*" Published by the American Association of State Highway and Transportation Officials Washington DC.
 29. Zaghoul, Sameh, et al "*Project Scoping Using FWD Testing – New Jersey Experience*" presented at the 1998 Annual Meeting of the Transportation Research Board, Washington DC January 1998